

Final Draft TIA

477 9th Avenue TIA

Prepared for:
City of San Mateo

July 6, 2023

SF22-1251.02

FEHR  PEERS

477 9th Avenue TIA Executive Summary

This transportation impact assessment (TIA) reviews transportation conditions at and adjacent to 477 9th Avenue, in the City of San Mateo. The proposed project will not result in CEQA impacts on VMT, bicycle, pedestrian, or transit circulation, or hazards and emergency access. The addition of project traffic would not result in unacceptable traffic operations. The project presents no adverse circulation issues and meets the code of design. The following summarizes the findings in the TIA and the recommended changes to the site plan would ensure consistency with San Mateo standards and best planning practices.



*Image is a current representation of the project

THE PROJECT

- 1.6** acre parcel
- 5** story mixed use building
- 27** thousand square feet of office space
- 120** residential units
- 153** on-site parking spaces

ADDITIONAL TRANSPORTATION ANALYSIS

No adverse effects to vehicle, transit, bicycle, or pedestrian circulation are created by the project.



- » **34** new AM peak hour and **43** new PM peak hour vehicle trips compared to existing land uses



- » **132** long-term bicycle parking spaces on-site
- » **10** short-term bicycle parking spaces on-site

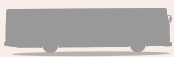

- » Project will **generate new riders** on Caltrain and SamTrans



- » **3** pedestrian access points
- » Proposed sidewalks with a width of 12'
- » Proposed sidewalks meet ADA standards

STUDY INTERSECTIONS & CEQA IMPACTS

- » **No adverse traffic conditions** during commute hours due to vehicle trips added by the project
- » **No significant VMT impact** due to proximity to high quality transit (within a 1/2 mile of Route ECR)
- » Minimal impact on neighborhood traffic
- » No new hazards or impact to emergency access

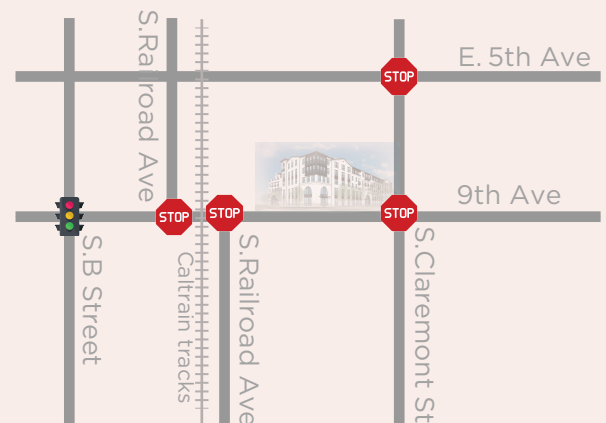

RECOMMENDATIONS

- » Add advance stop bars, high visibility crosswalks, curb extensions, and directional curb ramps at appropriate intersections in accordance with City of San Mateo's Pedestrian Design Guidelines and industry best practices.



Table of Contents

Executive Summary	1
Recommendations.....	1
Introduction	2
Study Area and Scenarios.....	3
Project Description	5
Existing Transportation Conditions	7
Existing Roadway Network.....	7
Existing Pedestrian Facilities.....	8
Existing Bicycle Facilities.....	8
Existing Transit Service.....	13
Existing Vehicle Volumes and Lane Configurations.....	16
Existing Intersection Level of Service.....	16
Existing Parking Conditions.....	19
Opening Year Conditions	20
Opening Year Conditions Intersection Level of Service.....	23
Project Conditions	24
Project Trip Generation and Distribution.....	24
Trip Generation.....	24
Trip Distribution.....	26
Plus Project VMT.....	28
VMT Screening.....	28
Opening Year Plus Project Vehicle Volumes and Level of Service.....	29
Cumulative Conditions	31
Cumulative Intersection Level of Service.....	34
Additional Transportation Analysis	36
Vehicle Site Access and Circulation.....	36
Loading and Curbside Management.....	37
Pedestrian & Bicycle Site Access and Circulation.....	38
Pedestrian Access.....	38
Bicycle Access.....	41
Transit Access and Circulation.....	42

Vehicle Parking Conditions	42
Hazards and Emergency Vehicle Access.....	42
Neighborhood Traffic.....	43
Conclusion.....	45
Recommendations.....	45

Appendices

- Appendix A: LOS Calculation Worksheets
- Appendix B: Existing Traffic Counts

List of Figures

Figure 1: Project Location.....	4
Figure 2: Existing and Proposed Bicycle Facilities.....	12
Figure 3: Existing Transit Routes.....	15
Figure 4: Existing Vehicle Volumes.....	17
Figure 5: Background Project Sites.....	21
Figure 6: Opening Year Vehicle Volumes.....	22
Figure 7: Trip Distribution and Assignment of Project Trips.....	27
Figure 8: Opening Year Plus Project Vehicle Volumes.....	30
Figure 9: Cumulative Vehicle Volumes.....	32
Figure 10: Cumulative Plus Project Vehicle Volumes.....	33
Figure 11: Project Site Plan.....	44

List of Tables

Table 1: Existing Transit Service.....	13
Table 2: Signalized Intersection LOS Criteria.....	18
Table 3: Unsignalized Intersection LOS Criteria.....	18
Table 4: Existing LOS and Delay Results.....	19
Table 5: Opening Year LOS and Delay Results.....	23
Table 6: Project Vehicle Trip Generation.....	25
Table 7: Opening Year Plus Project LOS and Delay Results.....	29
Table 8: Cumulative LOS and Delay Results.....	35
Table 9: Existing and Proposed Pedestrian Facilities.....	39

Executive Summary

This transportation impact assessment (TIA) reviews transportation conditions at and adjacent to the mixed-use project at 477 9th Avenue (“the project”), in the City of San Mateo. The proposed project will not result in CEQA impacts on VMT, bicycle, pedestrian, or transit circulation, or hazards and emergency access. The addition of project traffic would not result in unacceptable traffic operations. The project presents no adverse circulation issues and meets the code of design. The following recommended changes to the site plan and the adjacent intersection would ensure consistency with San Mateo standards and best planning practices.

Recommendations

- The project sponsor should include directional curb ramps and a curb extension at the northwest corner of the intersection of 9th Avenue and South Claremont Street.
- The project sponsor should include high visibility crosswalks at the intersection of 9th Avenue and South Claremont Street and at the intersection of 9th Avenue and South Railroad Avenue to improve pedestrian access to transit.
- The project sponsor should include advance stop bars at the intersection of 9th Avenue and South Claremont Street to increase visibility between pedestrians and drivers.
- The City should consider the installation of a curb ramp at the intersection of 9th Avenue and South Railroad Avenue.



Introduction

This transportation impact assessment (TIA) reviews transportation conditions at and adjacent to the mixed-use project located at 477 9th Avenue in the City of San Mateo. Conditions are evaluated for the current site without the proposed project, for near-term conditions with and without the proposed project, and for future conditions with and without the proposed project. The topics presented herein are based on the City of San Mateo's *Transportation Impact Analysis (TIA) Guidelines* (July 2020) and are intended to disclose the transportation related CEQA impacts and local transportation effects of the project. These topics include an assessment of vehicle level of service, vehicle miles traveled, site access and circulation, driveway site distance and vehicle queuing, parking, hazards and emergency vehicle access, and neighborhood traffic.



Study Area and Scenarios

The project site consists of a 69,976 square foot (1.6 acre) parcel at the corner of 9th Avenue and South Claremont Street. The project site is bounded to the north by an office building, located along South Claremont Street, and by railroad tracks directly to the west. The study area, as shown in **Figure 1** is situated in downtown San Mateo between El Camino Real and U.S. 101. The project site is located within one-half mile of the SamTrans Route ECR stop at 9th Avenue and the San Mateo Caltrain station.

Based on recent changes to the California Environmental Quality Act (CEQA) guidelines with the implementation of SB 743 and guidance from the OPR, vehicle miles traveled (VMT) is recommended as the appropriate measure of transportation impacts under CEQA. Level of service (LOS) and other similar vehicle delay or capacity metrics can no longer serve as transportation impact metrics for CEQA analysis. As stated in the City's TIA Guidelines, the City of San Mateo shifted to using VMT for CEQA impact evaluation but continues to evaluate LOS analysis for land use development projects through the non-CEQA local transportation analysis. Based on these guidelines, five intersections would qualify as study intersections within the project vicinity:

- East 5th Avenue and South Claremont Street
- 9th Avenue and South Claremont Street
- 9th Avenue and South Railroad Avenue (East)
- 9th Avenue and South Railroad Avenue (West)
- 9th Avenue and South B Street

Transportation conditions were evaluated for the weekday peak periods of 7:00-9:00 AM and 4:00-6:00 PM in a manner consistent with the TIA Guidelines. Traffic conditions were evaluated for the following scenarios:

- Existing Conditions: Existing traffic volumes were based on in-person vehicle counts collected at the five study intersections on Wednesday, November 16, 2022.
- Opening Year Conditions: Existing traffic volumes plus traffic generated by approved but not yet completed or occupied developments near the project site.
- Opening Year Plus Project Conditions: Project generated trips added to opening year traffic volumes.
- Cumulative No Project Conditions: Cumulative no project conditions reflect estimated future traffic volumes with the project trips removed from the study intersections.
- Cumulative Plus Project Conditions: Cumulative plus project conditions reflect estimated future traffic volumes for the year 2040, or 17 years into the future, including the project-generated vehicle trips.



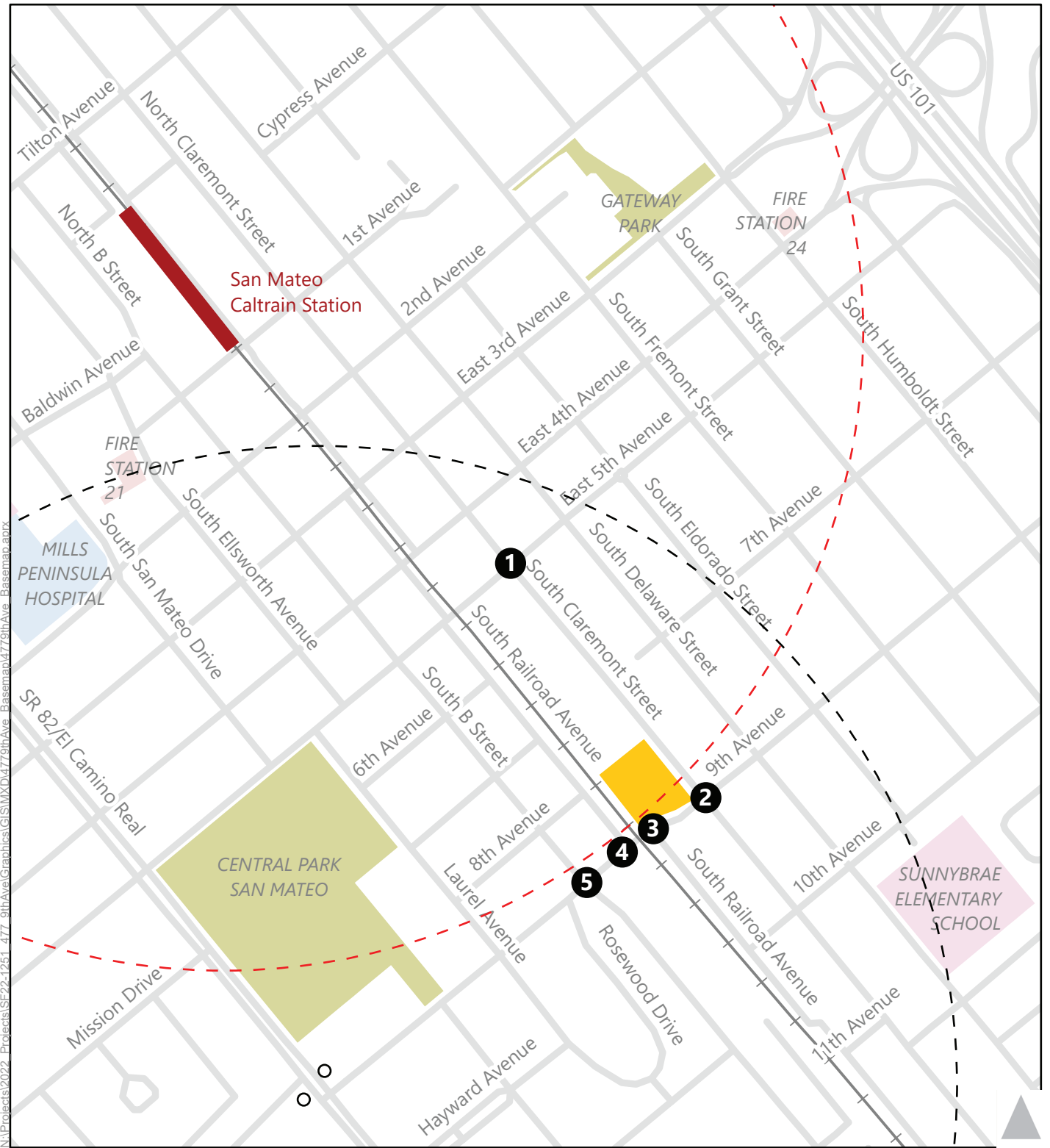

N:\Projects\2022_P\Projects\SF22-1251_477_9thAve\Graphics\GIS\MXD\1779\hAve_Basemap.aprx

- Study Area
- Caltrain Station - 0.5 Mile Radius
- Route ECR Stops - 0.5 Mile Radius
- X Study Intersections
- SamTrans ECR Stop



Figure 1
Project Location

Project Description

The project site currently consists of a 21,600 square foot single-story office building and surface parking lot at the corner of 9th Avenue and South Claremont Street. The parcel has a General Plan Designation of Executive Office and a zoning designation of E2-2, Executive Offices. The project site is bounded directly to the north by office uses along South Claremont Street, and railroad tracks directly to the west. SamTrans Route ECR and the San Mateo Caltrain station are located within one-half mile of the project.

The project proposes the demolition of the existing office building and the construction of a 209,204 square foot, five story mixed use building. The lower two floors would contain 28,100 square feet of office uses, a 144-stall parking garage, and the building lobby, leasing office, secure bicycle parking, and fitness center. The upper three floors include 120 residential units, including 24 studio, 64 one bedroom, and 32 two-bedroom apartments. The project would include 12 Below Market Units (BMR) in accordance with the City of San Mateo BMR Ordinance (15% Very Low-Income) and is requesting the use of State Density Bonus concessions and waivers as described in the State Density Bonus letter submitted with the project.

There will be two primary pedestrian entries to the building through the plaza on 9th Avenue. One entrance leads into the building lobby for residential access, while the other entrance provides direct access to the building's office space. Additionally, there is a pedestrian entry to the building's office space on South Claremont Street.

The project includes 153 parking stalls, including 112 parking stalls for the residential use of the project and 41 stalls for the office use. 144 parking stalls are provided in a parking garage, while the remaining 9 spaces are provided as surface parking. The City of San Mateo Zoning Code requires a combined total of 254 parking stalls for both the residential and office uses of the project. However, the project's use of the State Density Bonus reduces the required residential parking to 60 units. Further, with the recent passage of AB 2097, City of San Mateo is no longer allowed to enforce parking requirements for developments within one-half mile of high-quality transit.¹ Due to AB 2097, the project is not required to provide any parking or pay in-lieu fees, as the project is located within one-half mile of the San Mateo Caltrain station. Therefore, the project's proposed 153 parking stalls exceeds the minimum requirement of zero parking stalls. Trips by personal automobile to and from the project site are expected to primarily use the building's parking garage and surface parking, which has entrances and exits on 9th Avenue and South Claremont Street.

The project will also include a robust Transportation Demand Management (TDM) plan that would result in a substantial decrease in the number of trips generated by the proposed project and would decrease the proposed project's parking demand when compared to typical projects of this use and size. TDM

¹ California Legislative, AB-2097 Residential, commercial, or other development types: parking requirements, 2022, https://leginfo.ca.gov/faces/billNavClient.xhtml?bill_id=202120220AB2097



measures would include transit pass subsidies, car share credits, and active transportation subsidies. The project also includes unbundled parking for the proposed residential uses.

The project proposes to widen sidewalks and provide street furnishings, additional street trees, and pedestrian scale lighting along the project frontages to meet City of San Mateo standards and promote connectivity and pedestrian safety in the project area.



Existing Transportation Conditions

The existing transportation conditions surrounding the project site relating to the following topics are presented below: the roadway network, pedestrian facilities, bicycle facilities, transit service, vehicle volumes and lane configurations, and parking conditions.

Existing Roadway Network

As shown in Figure 1, the project site is bound by 9th Avenue, South Claremont Street, the existing office use to the north, and the railroad tracks adjacent to the parcel to the west. El Camino Real/State Route 82 and US 101 are the two primary regional north-south access routes. Drivers use these facilities to reach State Route 92, which provides east-west regional access to the project site. The roadways described below include those that provide direct access to the project site.

9th Avenue is a two-way east-west street with one travel lane in each direction, Class II bicycle lanes in each direction, and parking and sidewalks on each side of the street. Between South B Street and South Claremont Avenue, 9th Avenue includes an at-grade railroad crossing including vehicle, bicycle, and pedestrian access. The roadway is approximately 50 feet wide, and each sidewalk is approximately five feet wide. Intersections along 9th Avenue near the project site are unsignalized, except for at South B Street and Delaware Street.

South Claremont Street is a two-way north-south street with one travel lane in each direction, diagonal on-street parking, Class II bicycle lanes south of 9th Avenue, Class III bikeway markings north of 9th Avenue, and sidewalks on each side of the street. The roadway adjacent to the proposed project site is approximately 55 feet wide. The sidewalks are approximately nine feet wide.

East 5th Avenue is a two-way east-west street with one travel lane in each direction and parking and sidewalks on each side of the street. Between South B Street and South Claremont Avenue, East 5th Avenue includes an at-grade railroad crossing which allows for pedestrian access. The roadway is approximately 40 feet wide with approximately eight-foot sidewalks on the south side of the road and seven-foot sidewalks on the north side of the road.

South Railroad Avenue has two separate segments to the north and south of 9th Avenue. North of 9th Avenue, South Railroad Avenue is one-way southbound located to the west of the railroad tracks. In this segment, the roadway is approximately 35 feet wide, includes diagonal on-street parking on the east side of the street and a narrow (three feet wide) sidewalk on the west side of the street without curb ramps at 9th Avenue. South of 9th Avenue, South Railroad Avenue is a two-way north-south street located to the east of the railroad tracks with one travel lane in each direction. There are sidewalks on the east side of the street and street parking on both sides of the street. The roadway is approximately 30 feet wide, and the sidewalks are approximately six feet wide.



South B Street is a two-way north-west street with one travel lane in each direction. There is on street parking along the entire corridor and sharrows striped along the corridor denoting a Class III bikeway. The roadway is approximately 45 feet wide, and each sidewalk is approximately seven to nine feet wide. South B Street provides direct access to Downtown San Mateo.

Existing Pedestrian Facilities

Sidewalks are provided on all streets near the project site, except South Railroad Avenue where sidewalks are present on one side of the street and do not meet ADA requirements with missing curb ramps and narrow widths. Most of the land uses along South Railroad Avenue are auto-oriented uses and thus there are few destinations that people walking could not use parallel ADA-accessible pathways on South B Street to access.

The adjacent intersection is an unsignalized all way stop with marked crosswalks. Sidewalks adjacent to the project site on 9th Avenue and South Claremont Street are approximately five to nine feet wide and are generally in good condition with single curb ramps at all intersections. All curb ramps, except for the ramp at the southeast corner of the intersection, include truncated domes.

In the last four years, there has been one pedestrian/vehicle collision reported at the five study intersections as a result of vehicles colliding with pedestrians while crossing at the crosswalk. This collision occurred at the intersection of East 5th Avenue and South Claremont Street and resulted in a severe injury.²

Existing Bicycle Facilities

Bikeway planning and design in California typically relies on guidelines and design standards established by California Department of Transportation (Caltrans) in the *Highway Design Manual* (Chapter 1000: Bikeway Planning and Design). The Caltrans guidelines cover four primary types of bikeway facilities: Class I, Class II, Class III, and Class IV. These facility types are described below.

Class I Bikeway (Bike Path) provides a completely separate right-of-way, is designated for the exclusive use of bicycles and pedestrians and minimizes vehicle and pedestrian cross-flow. In general, bike paths serve corridors that are not served by existing streets and highways, or where sufficient right-of-way exists for such facilities to be constructed.

² City of San Mateo Collision Data, 2022,
https://experience.arcgis.com/experience/8a9f7321d1ce46ffbc0e1f04757efb5f/page/Maps/?data_id=dataSource_8-Traffic_Data_Public_6061_807%3A72208&views=Pedestrian-Collisions



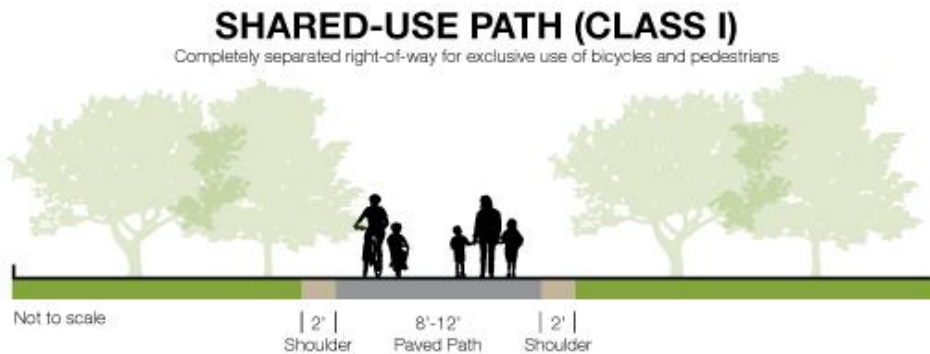

Class II Bikeways (Bike Lanes) are lanes for bicyclists generally adjacent to the outer vehicle travel lanes. These lanes have special lane markings, pavement legends, and signage. Bicycle lanes are generally five feet wide. Adjacent vehicle parking and vehicle/pedestrian cross-flow are permitted. Note that when grade separation or buffers are constructed between the bicycle and vehicle lanes, these facilities are classified as Class IV Separated Bikeways.

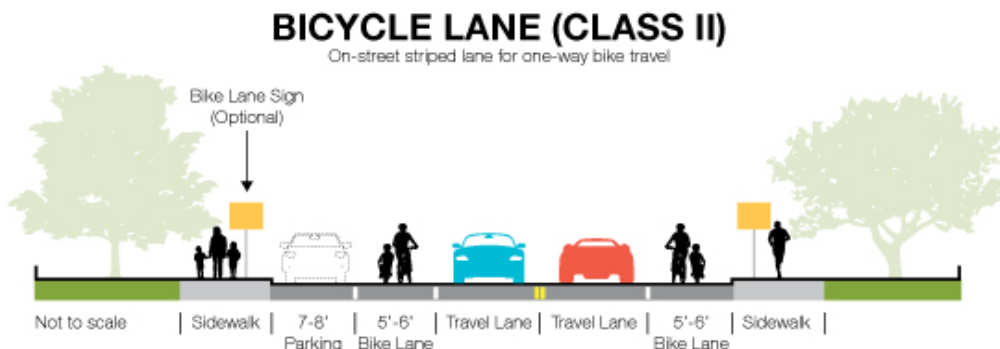

Class III Bikeway (Bicycle Routes/Bicycle Boulevards) are designated by signs or pavement markings for shared use with pedestrians or motor vehicles but have no separated bicycle right-of-way or lane striping. Bicycle routes serve either to a) provide continuity to other bicycle facilities, or b) designate preferred routes through high demand corridors. Bicycle routes are implemented on low-speed (less than 25 mph) and low-volume (less than 3,000 vehicles/day) streets. The San Mateo Bicycle Master Plan also designates a special subset of Bicycle Routes which include traffic calming treatments as Bicycle Boulevards.



BICYCLE BOULEVARD (CLASS III)

Shared on-street facility with improvements to prioritize bicycle traffic

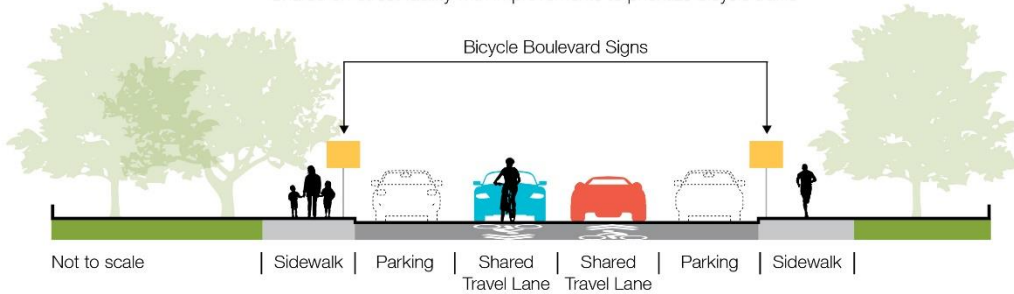

- Class IV Bikeway (Cycle Tracks/Protected Bike Lanes) provide a right-of-way designated exclusively for bicycle travel within a roadway and which are protected from other vehicle traffic with devices, including, but not limited to, grade separation, flexible posts, inflexible physical barriers, or parked cars.

CYCLE TRACK/SEPARATED BIKEWAY (CLASS IV)

Physically separated bike lane

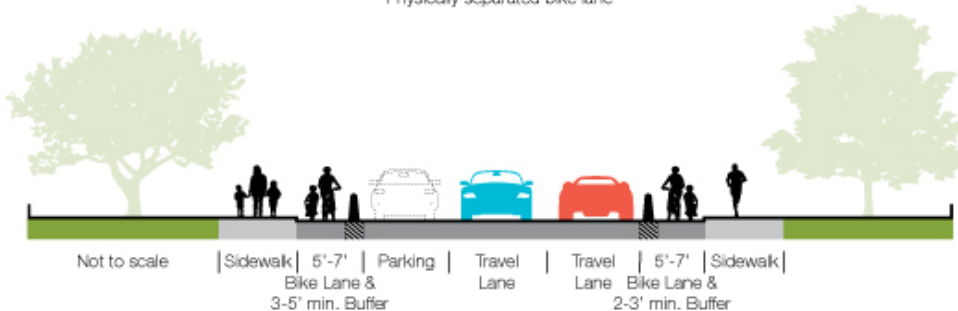

Existing bicycle facilities near the project site include Class II bike lanes on 9th Avenue, Class II bike lanes on South Claremont Street south of 9th Avenue, a Class III bicycle route on South Claremont Street north of 9th Avenue, Class II bike lanes on South Delaware Street, and a Class III bicycle route on South B Street.

As shown on *Figure 3.7 of the 2020 San Mateo Bicycle Master Plan*³, the bicycle facility along South B Street is considered to have a high “Level of Traffic Stress” (LTS).⁴ LTS measures bicycling comfort based on roadway characteristics. Low stress bikeways are comfortable for everyone to ride on, including people who would be categorized as “interested but concerned”. In contrast, high stress bikeways are only tolerated by a few: primarily those who could be described as “strong and fearless” – those comfortable

³ *San Mateo Bicycle Master Plan*, City of San Mateo & Toole Design, 2020, p 28.

⁴ The LTS Methodology was developed by Mekuria, Furth, and Nixon in *Low Stress Bicycling and Network Connectivity* (2012).



riding under any conditions (about 7% of the population). Class II and Class III bicycle facilities on roadways with multiple lanes of vehicle traffic and speed limits above 25 miles per hour would be categorized as high stress bikeways. As such, South Claremont Street and South Delaware Street are expected to be the primary north-south streets for bicycle access, and it would be unlikely that any but the most confident and fearless bicyclists would feel comfortable bicycling to the project site along South B Street with the current infrastructure.

The City of San Mateo, through the 2020 Bicycle Master Plan, has proposed a Class III bicycle boulevard on South Claremont Street north of 9th Avenue, Class II buffered bicycle lanes on South B Street and South Delaware Street, and a Class III bicycle boulevard on South Railroad Avenue south of 9th Avenue. The bicycle improvements on South Claremont Street, South B Street and South Delaware Street are considered high priority as shown on *Figure 6.1* of the *2020 San Mateo Bicycle Master Plan*.⁵ Existing and proposed bicycle facilities are shown on **Figure 2**.

⁵ *San Mateo Bicycle Master Plan*, City of San Mateo & Toole Design, 2020, p 60.





N:\Projects\2022_P\Projects\SF22-1251_477_9thAve\Graphics\GIS\MXD\1779thAve_BaseMap.aprx

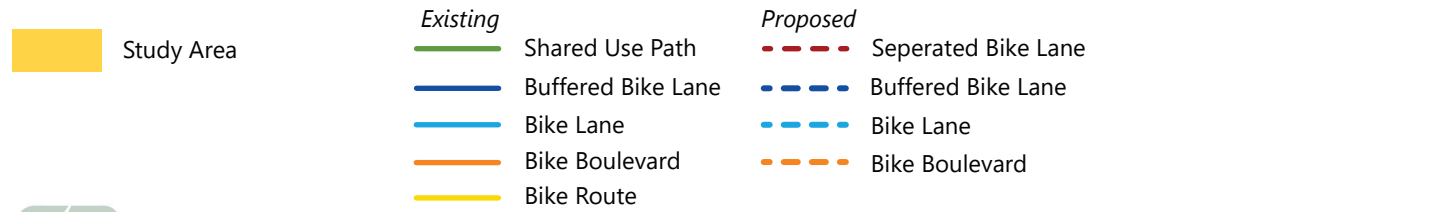

Figure 2
Existing and Proposed Bicycle Facilities

Existing Transit Service

Table 1 and **Figure 3** present the existing transit service providers and routes that provide service near the project site. SamTrans is the primary regional and local transit provider within San Mateo County, serving all Caltrain regional rail stations within the County and major transit transfer points for Santa Clara, Alameda, and San Francisco counties. The schedule information below reflects January 2023 timetables.

Table 1: Existing Transit Service

Route	Weekday Peak Headway (minutes)	Weekend Peak Headway (minutes)	Hours of Operation	Closest Stop(s) to Project Site	Key Destinations Served by Route
SamTrans 53	-	-	School Drop Off/Pick Up Hours Only	Delaware Street and 10 th Street	Peninsula/Humboldt, Borel Middle School
SamTrans 59	-	-	School Drop Off/Pick Up Hours Only	Delaware Street and 4 th Avenue	Hillsdale/Norfolk, Aragon High School
SamTrans 250	30	60	Weekdays: 5:50 AM – 11:00 PM; Saturdays: 7:00 AM – 8:40 PM	Delaware Street and 4 th Avenue	San Mateo and Hillsdale Caltrain Station, College of San Mateo
SamTrans 292	20-30	30	Weekdays and Weekends: 3:55 AM – 2:42 AM	Delaware Street and 10 th Street	Downtown San Francisco, SFO, all Caltrain stations in the city of San Mateo, Hillsdale Mall
SamTrans 397	45	45	Weekdays and Saturdays: Early AM hours (1:00 AM – 6:40 AM)	El Camino Real and 9 th Avenue	Palo Alto Transit Center, Downtown San Francisco, San Francisco Airport, Millbrae Transit Center, Hillsdale Caltrain Station
SamTrans ECR	15-20	20-30	All day	El Camino Real and 9 th Avenue	Multiple BART stations, all Caltrain stations in the city of San Mateo, Palo Alto Transit Center
Caltrain	30	60	Weekdays: 5:28 AM – 12:16 AM; Weekends: 8:19 AM – 12:41 AM	San Mateo Station	San Francisco, San Jose

Note: Transit service is representative of June 2023 operations.
 Source: SamTrans, Caltrain, and Fehr & Peers, 2023

The nearest SamTrans Route ECR stops are located at El Camino Real and 9th Avenue, which is approximately one third of a mile to the west of the project site. Route ECR provides service through the length of the Peninsula and connects with several other transit services, including BART and Caltrain. People walking between the project site and the Route ECR bus stops would use 9th Avenue to access El



Camino Real. Sidewalks, crosswalks, and street trees are provided along this walking route, and there are signalized pedestrian crossings at South B Street and El Camino Real. Existing land uses along 9th Avenue is primarily residential, and sidewalks along this path are generally in good condition and range between three and eight feet wide, which generally meet the recommended width in the City's Pedestrian Design Guidelines for streets with residential land uses. However, there are locations where the sidewalks along the direct walking path of travel to transit do not meet minimum widths nor ADA standards. On the north side of 9th Avenue, which presents the most walking path from the project site to the transit stops at El Camino Real, the intersection of 9th Avenue and South Railroad Avenue has obstacles that narrow the width to less than four feet and the corner does not include an ADA curb ramp. The south side of 9th Avenue has non-ADA compliant curbs at the parking lot driveway east of B Street. These obstacles may limit the ability for some mobility impaired users to reach transit service on El Camino Real.



Inset 1: Obstacles on the pedestrian path of travel on 9th Avenue at South Railroad Avenue (right image) and at South B Street. *Source: Google Streetview.*

Four regular SamTrans routes provide access to all major Caltrain Stations, BART, downtown San Francisco, and other major attractions in the City of San Mateo. The nearby Route ECR and Route 397 bus stops on El Camino Real include an unsheltered bench at the northbound stop and a sheltered bench at the southbound stop. The bus stops at South Delaware Street and 10th Avenue, which are served by Route 53 and Route 292, also lack benches and pedestrian-scaled lighting. Sidewalks along these bus stops are narrow and do not provide adequate waiting space. The City of San Mateo and SamTrans are currently assessing bus stop amenities and the pedestrian facilities surrounding transit stops, and these improvements may address the deficiencies noted above.





N:\Projects\2022_P\Projects\SF22-1251_477_9thAve\Graphics\GIS\MXD\1779\hAve_Basemap.aprx



Figure 3
Existing Transit Routes

Existing Vehicle Volumes and Lane Configurations

Intersection turning movement counts were collected in November 2022 for both the AM peak period (7:00-9:00 AM) and PM peak period (4:00-6:00 PM). These counts include the number of automobiles, cyclists, and pedestrians at each of the five study intersections. In addition to these turning movement counts, 24-hour vehicle counts were collected on 9th Avenue and on South Claremont Street in November 2022. The existing lane configuration and traffic volumes for this intersection are shown on **Figure 4**.

Existing Intersection Level of Service

Five locations were identified as study intersections within the project vicinity:

- East 5th Avenue and South Claremont Street (all-way stop-controlled)
- 9th Avenue and South Claremont Street (all-way stop-controlled)
- 9th Avenue and South Railroad Avenue [East] (side-street stop-controlled)
- 9th Avenue and South Railroad Avenue [West] (side-street stop-controlled)
- 9th Avenue and South B Street (signalized)

One of the five study intersections is signalized: 9th Avenue and South B Street. The San Mateo General Plan, through the TIA Guidelines, requires the City to *maintain a Level of Service no worse than mid LOS D, average delay of 45.0 seconds, as the acceptable Level of Service for all signalized intersections within the City. Adverse traffic operations are to be noted if a signalized intersection operating at acceptable LOS is triggered to operate at unacceptable levels of service (from mid LOS D or better to E or F) or increases in the average delay for a signalized intersection that is already operating at unacceptable LOS by 4.0 seconds or more.*

For unsignalized intersections, the guidelines require the City to *maintain a Level of Service no worse than LOS E for unsignalized intersections. Adverse traffic operations are to be noted if an unsignalized intersection operating at acceptable LOS is triggered to operate at unacceptable levels of service (from E or better to F) or increases the average delay for an unsignalized intersection that is already operating at unacceptable LOS by 4.0 or more seconds.*

In order to evaluate these policies, the City uses the metric Level of Service ("LOS"), which is a qualitative description of driver comfort and convenience. Typical factors that affect motorized vehicle LOS include speed, travel time, traffic interruptions, and freedom to maneuver. Typical LOS criteria for signalized and unsignalized intersections are defined in **Table 2** and **Table 3**, respectively.



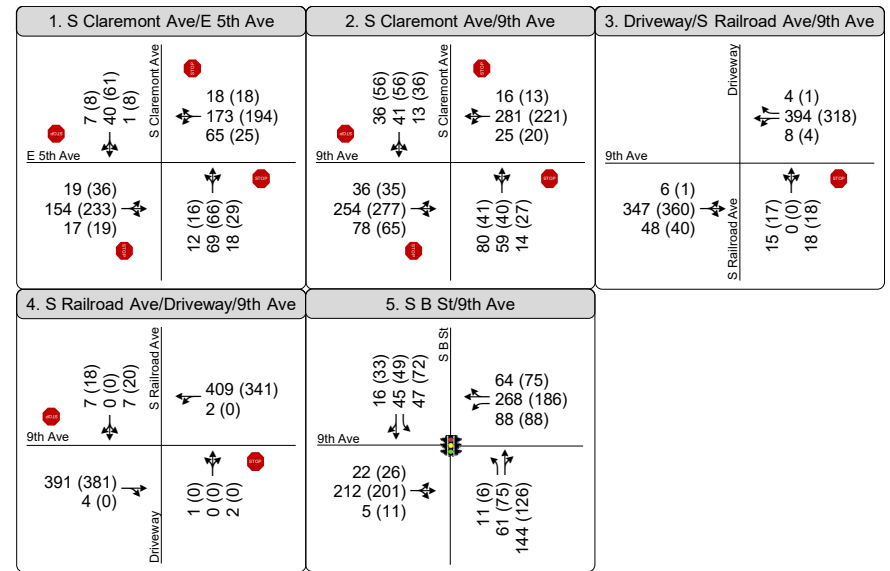
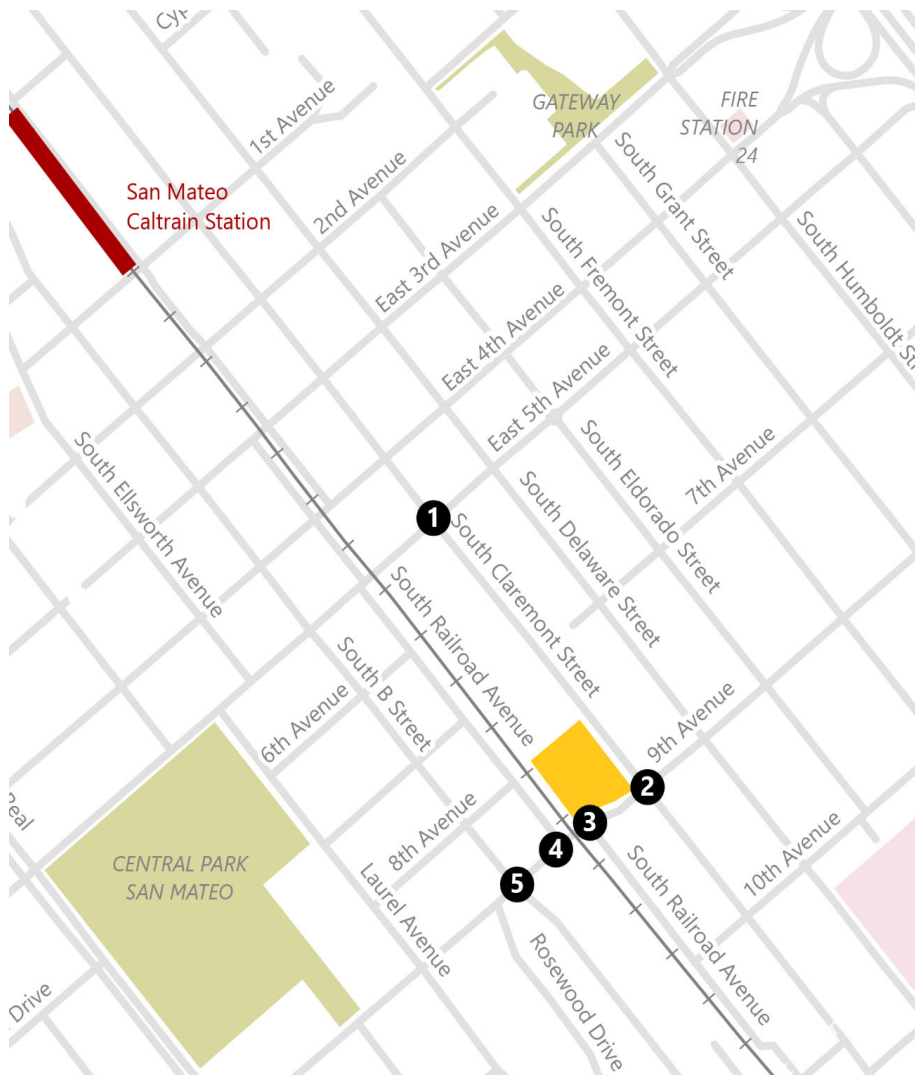

XX (YY) AM (PM) Project Trip Volumes
 Signalized Intersection
 Stop Sign
 Project Site
 Study Intersection

Figure 4
Existing Vehicle Volumes
Intersection Traffic Volumes, Lane Configurations, and Traffic Controls



Table 2: Signalized Intersection LOS Criteria

Level of Service	Description	Average Control Delay Per Vehicle (Seconds)
A	Operations with very low delay occurring with favorable progression and/or short cycle length.	≤ 10
B	Operations with low delay occurring with good progression and/or short cycle lengths.	> 10 and ≤ 20
C	Operations with average delays resulting from fair progression and/or longer cycle lengths. Individual cycle failures begin to appear.	> 20 and ≤ 35
D	Operations with longer delays due to a combination of unfavorable progression, long cycle lengths, or high volume-to-capacity (V/C) ratios. Many vehicles stop and individual cycle failures are noticeable.	> 35 and ≤ 55
E	Operations with high delay values indicating poor progression, long cycle lengths, and high V/C ratios. Individual cycle failures are frequent occurrences.	> 55 and ≤ 80
F	Operation with delays unacceptable to most drivers occurring due to over saturation poor progression, or very long cycle lengths.	> 80

Source: Transportation Research Board, 2016. *Highway Capacity Manual* 6th Edition

Table 3: Unsignalized Intersection LOS Criteria

Description	LOS	Average Control Delay (seconds per vehicle)
		Unsignalized Intersections
Represents free flow. Individual users are virtually unaffected by others in the traffic stream.	A	≤ 10
Stable flow, but the presence of other users in the traffic stream begins to be noticeable.	B	> 10 to 15
Stable flow, but the operation of individual users becomes significantly affected by interactions with others in the traffic stream.	C	> 15 to 25
Represents high-density, but stable flow.	D	> 25 to 35
Represents operating conditions at or near the capacity level.	E	> 35 to 50
Represents forced or breakdown flow.	F	> 50

Source: *Highway Capacity Manual* 6th Edition, Transportation Research Board of the National Academies of Science, 2017.

Table 4 below presents existing LOS and intersection delay in seconds for each study intersection. The study intersections perform acceptably under existing conditions in both the AM and PM peak periods. See **Appendix B** for detailed LOS results.



Table 4: Existing LOS and Delay Results

Intersection	LOS Threshold	Peak Hour	Existing	
			Delay	LOS
1. East 5 th Avenue and South Claremont Street	E	AM	9	A
		PM	11	B
2. 9 th Avenue and South Claremont Street	E	AM	15	B
		PM	12	B
3. 9 th Avenue and South Railroad Avenue (east)	E	AM	15 (NB)	C
		PM	14 (NB)	B
4. 9 th Avenue and South Railroad Avenue (west)	E	AM	16 (SB)	C
		PM	14 (SB)	B
5. 9 th Avenue and South B Street	Mid-D (45 Secs)	AM	14	B
		PM	13	B

Source: Fehr & Peers, 2023

Existing Parking Conditions

There is unmetered on-street parking along 9th Avenue and South Claremont Street, including 20 diagonal parking spaces on South Claremont Street, approximately five parallel parking spaces on 9th Avenue, and eight motorcycle parking spaces, located midblock between the project's South Claremont Avenue driveway and 9th Avenue. Parking along 9th Avenue is limited to two hours, 8:00 AM to 6:00 PM Monday through Saturday. Parking on South Claremont Street is limited on the first and third Thursday of each month from 7:00 AM to 9:00 AM for street sweeping.



Opening Year Conditions

The Opening Year reflects the anticipated transportation conditions at the time of the occupancy of the proposed project. Opening Year Conditions include traffic volumes added by nearby developments that have been approved but not yet completed or occupied near the project site. The approved project list includes:

- 180 East 3rd Avenue Office and Retail Mixed-Use Development
- 406 East 3rd Avenue Office and Residential Mixed-Use Development
- 222 East 4th Avenue (Draegers) Office, Retail, and Residential Mixed-Use Development
- 480 East 4th Avenue (Kiku Crossing) Residential Development
- Block 21 Office and Residential Mixed-Use Development
- 640 Concar Drive Retail and Residential Mixed-Use Development
- 210/200 South Fremont Residential Development
- 1 Hayward Avenue Office and Residential Mixed-Use Development

Approved projects that affect traffic volumes at study intersections include:

- 406 East 3rd Avenue Office and Residential Mixed-Use Development
- 222 East 4th Avenue (Draegers) Office, Retail, and Residential Mixed-Use Development
- 480 East 4th Avenue (Kiku Crossing) Residential Development
- Block 21 Office and Residential Mixed-Use Development

Figure 5 shows the location of these projects relative to the project site. Additionally, **Figure 5** shows nearby development projects that are currently being reviewed but have not received approval from the City of San Mateo.

Each of these projects proposes new pedestrian improvements including:

- Wider sidewalks with landscaping zone along the residential frontage of Kiku Crossing
- Crosswalks installed at all legs of the intersection of 5th Avenue and South Claremont Street
- Wider sidewalks along South Claremont Street and South Delaware Street

Vehicle volumes were extrapolated from the TIAs provided by the City of San Mateo for the nearby development projects listed above. Opening Year traffic volumes that include the estimated traffic generated by these development projects are shown in **Figure 6**.



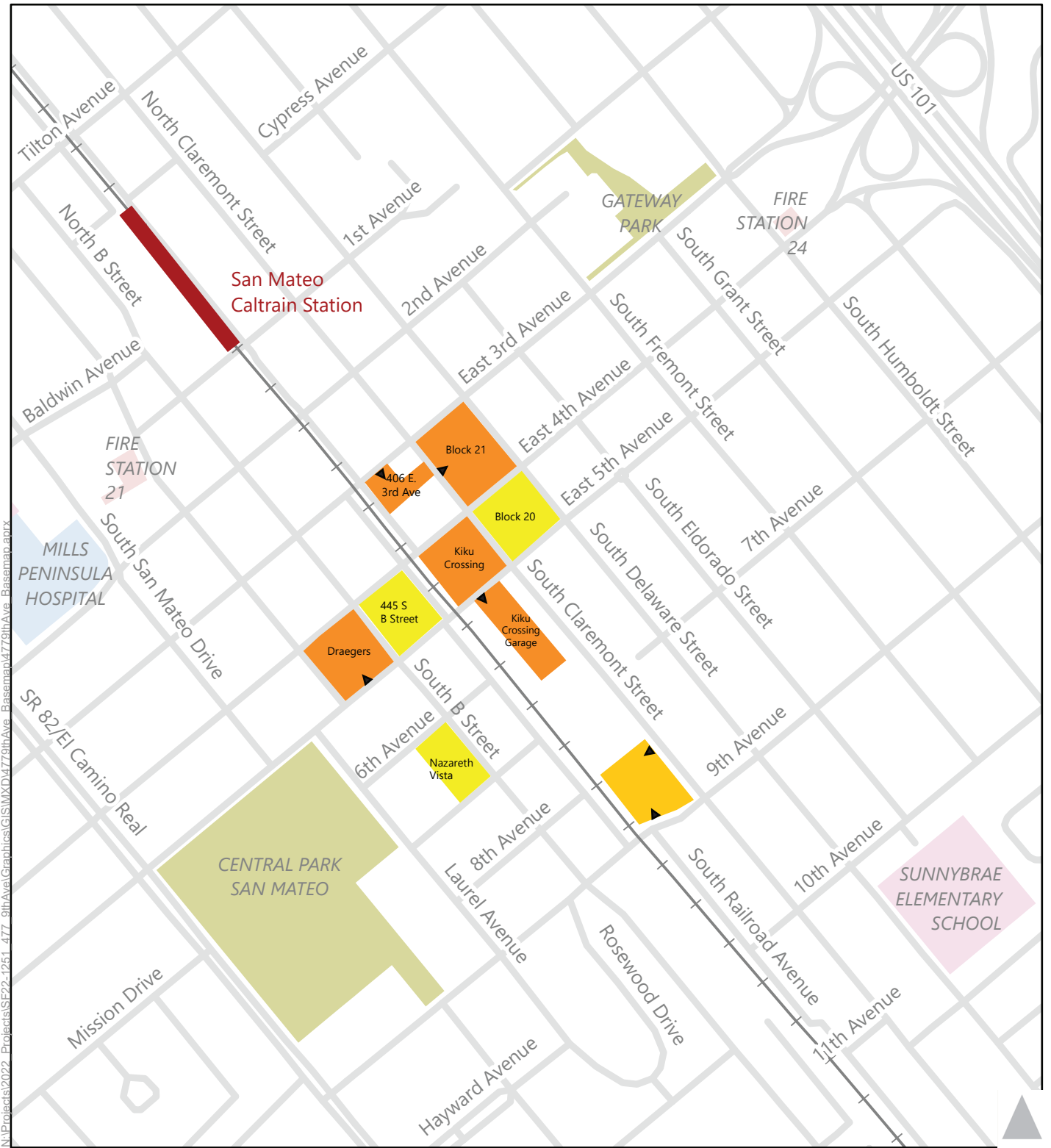

N:\Projects\2022_P\Projects\SF22-1251_477_9thAve\Graphics\GIS\MXD\1779\Ave_Basemap.aprx

- Study Area
- Background Projects
- Driveways
- Application Under Review
(included in cumulative traffic scenario)



Figure 5
Background Project Sites

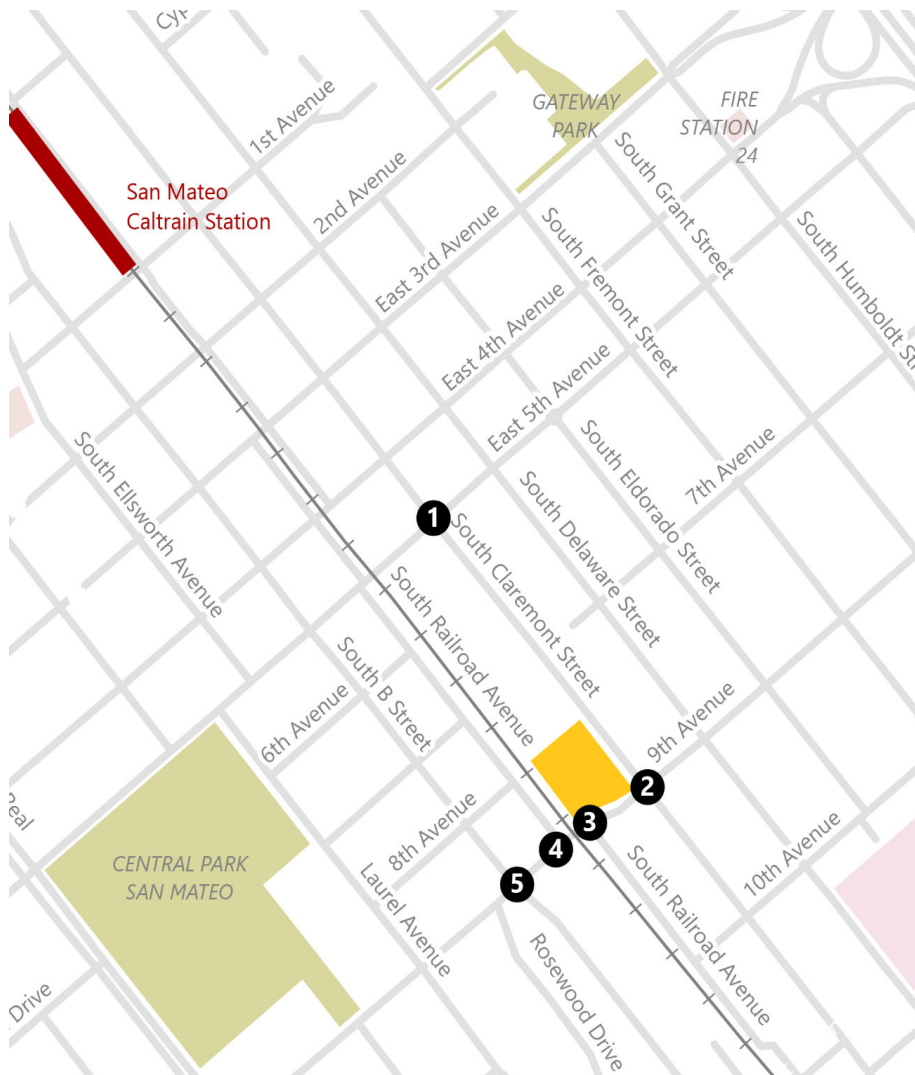

1. S Claremont Ave/E 5th Ave	2. S Claremont Ave/9th Ave	3. Driveway/S Railroad Ave/9th Ave
4. S Railroad Ave/Driveway/9th Ave	5. S B St/9th Ave	

XX (YY) AM (PM) Project Trip Volumes Signalized Intersection Stop Sign
 Project Site Study Intersection

Figure 6
Opening Year Vehicle Volumes
Intersection Traffic Volumes, Lane Configurations, and Traffic Controls



Opening Year Conditions Intersection Level of Service

Table 5 below presents opening year LOS and intersection delay in seconds for each study intersection. There are limited changes in LOS between existing conditions and opening year conditions as these projects would not substantially increase traffic volumes at these study locations. All the study intersections perform acceptably under opening year conditions in both the AM and PM peak periods. See **Appendix A** for detailed LOS results.

Table 5: Opening Year LOS and Delay Results

Intersection	LOS Threshold	Peak Hour	Existing		Opening Year	
			Delay	LOS	Delay	LOS
1. East 5 th Avenue and South Claremont Street	E	AM	9	A	11	B
		PM	11	B	17	C
2. 9 th Avenue and South Claremont Street	E	AM	15	B	14	B
		PM	12	B	12	B
3. 9 th Avenue and South Railroad Avenue (east)	E	AM	15 (NB)	C	17 (NB)	C
		PM	14 (NB)	B	15 (NB)	B
4. 9 th Avenue and South Railroad Avenue (west)	E	AM	16 (SB)	C	16 (SB)	C
		PM	14 (SB)	B	14 (SB)	B
5. 9 th Avenue and South B Street	Mid-D (45 Secs)	AM	14	B	14	B
		PM	13	B	13	B

Source: Fehr & Peers, 2023



Project Conditions

The project proposes a five-story mixed use development with office and residential uses. This section presents the traffic conditions with the project, including Vehicle Miles Traveled and LOS, while site access and circulation issues and other related topics are evaluated within the Additional Transportation Analysis sections.

Project Trip Generation and Distribution

Trip Generation

Vehicle trip estimates for the project were developed by applying national trip generation rates presented in the Institute of Transportation Engineers (ITE) Trip Generation Manual 11th Edition to the proposed land uses: "Multifamily Housing Low-Rise (220)" and "General Office (710)." Fehr & Peers used the trip generation methodology known as MXD to calibrate the trip generation estimates to the mixed-use nature of the project and the proximity of the project to transit, amenities, services, and other commercial and residential uses.⁶ The MXD method accounts for built environment factors present in Downtown San Mateo that the ITE Trip Generation Manual does not account for, such as the diversity of land uses, design of the pedestrian and bicycling environment, demographics of the site, and distance to transit. MXD trip generation approach relies on these variables to measure the degree of interactivity within the site and the accessibility of the site location for non-automobile trips, then adjusts the conventional ITE outputs accordingly to produce a more accurate trip generation forecast. Trip reductions from internal capture represent trips between the two land uses (e.g., residents who may work in the office space). Trip reductions from walk/bike trips represent external person trips that are taken by foot or by bicycle (e.g., residents commuting to their jobs elsewhere on foot or bike). To determine existing trip generation for the various uses, the ITE rates for General Office (710) were used. As shown in **Table 6** below, the trips generated by the existing uses to be removed were subtracted from the project trips generated. The proposed project would generate a total of 34 net new vehicle trips in the AM peak hour and 43 new vehicle trips in the PM peak hour.

⁶ For more information, visit <https://www.fehrandpeers.com/mxd/>. MXD methodologies were developed in tandem with the EPA as documented in the American Planning Association PAS Memo "Getting Trip Generation Right: Eliminating the Bias Against Mixed Use Development" by Jerry Walters, Brian Bochner, and Reid Ewing (May 2013). This paper can be accessed here: https://www.fehrandpeers.com/wp-content/uploads/2019/11/APA_PAS_May2013_GettingTripGenRight-2.pdf. These methodologies were revalidated as documented in the November/December 2020 issue of the APA's PAS Memo, entitled "[Still Getting Trip Generation Right: Revalidating MXD+](#)".



Table 6: Project Vehicle Trip Generation

Land Use	ITE LU Code	Quantity	Units ¹	Daily	AM			PM		
				Total	In	Out	Total	In	Out	Total
Proposed project										
Multifamily Low-Rise	220	120	DU	845	14	46	60	45	27	72
General Office Building	710	28	KSF	304	38	5	43	7	33	40
<i>Reductions compared to isolated suburban land uses²</i>										
Internal Capture				-40	-3	-3	-6	-2	-2	-4
External Walk, Bike, and Transit				-409	-17	-17	-34	-16	-20	-36
Proposed Project Subtotal				700	32	31	63	34	38	72
Existing Uses										
General Office Building	710	22	KSF	238	29	4	33	5	27	32
<i>Reductions compared to isolated suburban land uses²</i>										
Internal Capture				0	0	0	0	0	0	0
External Walk, Bike, and Transit				-27	-4	0	-4	0	-3	-3
Existing Uses Subtotal				211	25	4	29	5	24	29
Net new trips (Proposed project minus existing)				489	7	27	34	29	14	43

Notes: Assumes 100% of existing uses were occupied

1. DU=dwelling unit; KSF=1,000 square feet
2. Based on MXD trip generation methodology which accounts for built environment factors not accounted in the ITE Trip Generation Manual such as diversity of land uses, design of the pedestrian and bicycle environment, site demographics, and accessibility of transit, among other factors. Internal trip reductions account for trips made between land uses on the site.

Sources: Fehr & Peers; ITE Trip Generation Manual, 11th Edition, 2023

Accounting for the mix of nearby land uses (e.g., employees who live within walking distance or shopping/restaurant trips that are made by walking) and the access to transit including Caltrain and SamTrans, the MXD method estimates a 35 to 40 percent reduction in automobile trips compared to the isolated single-use land uses presented in the ITE Trip Generation manual. This analysis does not account for a robust transportation demand management (TDM) program for conservative purposes because the TDM plan and monitoring measures are not yet defined. This project includes some of the most effective TDM measures, including the project’s density, mix of land uses, and transit-oriented location.⁷ Additional programmatic and design measures through the project’s TDM program could further reduce the automobile mode share, vehicle trips, and parking demand.

The MXD results can be compared to available mode share data and vehicle trip counts in nearby communities to assess how reasonable these results are. Recent studies of travel behavior in Downtown

⁷ California Air Pollution Control Officers Association’s (CAPCOA) Handbook, December 2021. Available at: https://www.airquality.org/ClimateChange/Documents/Final%20Handbook_AB434.pdf



Redwood City and Downtown Palo Alto found that approximately 45 percent and 52 percent of employees drive alone in the two cities, respectively.⁸ These mode shares are 30 to 40 percent lower than the average U.S. drive alone rate. The Palo Alto study segmented the mode share by type of employment use, with the two uses most likely to have robust TDM programs (technology and government) achieving an approximately 40 percent drive alone mode share. Vehicle counts collected at mixed-use residential and office buildings adjacent to the Hillsdale Caltrain station by the San Mateo Rail Corridor Transportation Management Agency (TMA) were 40 to 50 percent lower than traditional suburban buildings.⁹ Therefore, the MXD results reasonably fall within the range of similar residential and office buildings in a similar context.

Trip Distribution

Trips generated by the project were distributed through the five study intersections based on the existing travel patterns on the surrounding roadway system and the locations of complementary land uses. The peak-hour trips generated by the existing and proposed uses were assigned to the roadway network based on the directions of approach and departure, the roadway network connections, and the location of freeway on/off ramps. The trip distribution patterns were compared to ensure consistency with other recent studies, such as the Block 21 office & residential mixed-use development.¹⁰ For the project, approximately 45% of trips would travel to and from the project site via US 101 North and South. These trips would use South Claremont Street to access the US 101 ramps on 3rd Avenue and East 4th Avenue. About 25% of trips would travel to Downtown San Mateo via South B Street and South Claremont Street. 20% of trips would use 9th Avenue to access El Camino Real to reach destinations to the north and south. Finally, approximately 10% of trips would use South Delaware Street to access destinations to the south, including the SR 92 ramps at Concar Drive and 19th Avenue. The trips generated by the existing uses to be removed were subtracted from the roadway network prior to assigning project trips. **Figure 7** shows the net project trip distribution and assignment of the project trips at the study intersections.

⁸ City of Redwood City. July 2018. Redwood City Moves. Page 8 presents a summary of the existing mode share for downtown Redwood City compared to suburban neighborhoods: http://rwcmoves.com/wp-content/uploads/2018/07/RWCmoves-Transportation-Plan_July16.pdf

City of Palo Alto, 2019 Palo Alto TMA Annual Report, May 2020. Appendix A presents the survey results by year and by sector: <https://www.cityofpaloalto.org/files/assets/public/agendas-minutes-reports/reports/city-manager-reports-cmrs/year-archive/2020/id-11307-tma-annual-report.pdf>

⁹ San Mateo Rail Corridor Transportation Management Agency. January 2018. 2017 Annual Report. This study included recently completed residential and office buildings in Bay Meadows, which 40 to 50 percent lower than traditional suburban buildings.

¹⁰ Fehr & Peers., *Block 21 Office & Residential Mixed-Use Development TIA*, April 2022.





1. S Claremont Ave/E 5th Ave	2. S Claremont Ave/9th Ave	3. Driveway/S Railroad Ave/9th Ave																																																																					
<table border="1"> <tr> <td>0 (0)</td> <td>0 (0)</td> <td>0 (0)</td> </tr> <tr> <td>1 (5)</td> <td>0 (0)</td> <td>0 (0)</td> </tr> <tr> <td>0 (0)</td> <td>0 (0)</td> <td>0 (0)</td> </tr> <tr> <td>0 (0)</td> <td>0 (0)</td> <td>0 (0)</td> </tr> <tr> <td>0 (0)</td> <td>0 (0)</td> <td>0 (0)</td> </tr> <tr> <td>1 (2)</td> <td>1 (3)</td> <td>0 (0)</td> </tr> <tr> <td>5 (2)</td> <td>0 (0)</td> <td>0 (0)</td> </tr> <tr> <td>5 (2)</td> <td>0 (0)</td> <td>0 (0)</td> </tr> </table>	0 (0)	0 (0)	0 (0)	1 (5)	0 (0)	0 (0)	0 (0)	0 (0)	0 (0)	0 (0)	0 (0)	0 (0)	0 (0)	0 (0)	0 (0)	1 (2)	1 (3)	0 (0)	5 (2)	0 (0)	0 (0)	5 (2)	0 (0)	0 (0)	<table border="1"> <tr> <td>0 (0)</td> <td>0 (0)</td> <td>0 (0)</td> </tr> <tr> <td>2 (1)</td> <td>1 (3)</td> <td>0 (0)</td> </tr> <tr> <td>0 (0)</td> <td>0 (0)</td> <td>0 (0)</td> </tr> <tr> <td>0 (0)</td> <td>0 (0)</td> <td>0 (0)</td> </tr> <tr> <td>0 (0)</td> <td>0 (0)</td> <td>0 (0)</td> </tr> <tr> <td>2 (1)</td> <td>0 (2)</td> <td>0 (0)</td> </tr> <tr> <td>0 (0)</td> <td>1 (2)</td> <td>0 (0)</td> </tr> <tr> <td>0 (0)</td> <td>0 (0)</td> <td>0 (0)</td> </tr> </table>	0 (0)	0 (0)	0 (0)	2 (1)	1 (3)	0 (0)	0 (0)	0 (0)	0 (0)	0 (0)	0 (0)	0 (0)	0 (0)	0 (0)	0 (0)	2 (1)	0 (2)	0 (0)	0 (0)	1 (2)	0 (0)	0 (0)	0 (0)	0 (0)	<table border="1"> <tr> <td>11 (16)</td> <td>9 (6)</td> <td>0 (0)</td> </tr> <tr> <td>0 (0)</td> <td>0 (0)</td> <td>0 (0)</td> </tr> <tr> <td>5 (5)</td> <td>0 (0)</td> <td>0 (0)</td> </tr> <tr> <td>14 (13)</td> <td>0 (0)</td> <td>0 (0)</td> </tr> <tr> <td>0 (0)</td> <td>0 (0)</td> <td>0 (0)</td> </tr> <tr> <td>0 (0)</td> <td>0 (0)</td> <td>0 (0)</td> </tr> <tr> <td>0 (0)</td> <td>0 (0)</td> <td>0 (0)</td> </tr> </table>	11 (16)	9 (6)	0 (0)	0 (0)	0 (0)	0 (0)	5 (5)	0 (0)	0 (0)	14 (13)	0 (0)	0 (0)	0 (0)	0 (0)	0 (0)	0 (0)	0 (0)	0 (0)	0 (0)	0 (0)	0 (0)
0 (0)	0 (0)	0 (0)																																																																					
1 (5)	0 (0)	0 (0)																																																																					
0 (0)	0 (0)	0 (0)																																																																					
0 (0)	0 (0)	0 (0)																																																																					
0 (0)	0 (0)	0 (0)																																																																					
1 (2)	1 (3)	0 (0)																																																																					
5 (2)	0 (0)	0 (0)																																																																					
5 (2)	0 (0)	0 (0)																																																																					
0 (0)	0 (0)	0 (0)																																																																					
2 (1)	1 (3)	0 (0)																																																																					
0 (0)	0 (0)	0 (0)																																																																					
0 (0)	0 (0)	0 (0)																																																																					
0 (0)	0 (0)	0 (0)																																																																					
2 (1)	0 (2)	0 (0)																																																																					
0 (0)	1 (2)	0 (0)																																																																					
0 (0)	0 (0)	0 (0)																																																																					
11 (16)	9 (6)	0 (0)																																																																					
0 (0)	0 (0)	0 (0)																																																																					
5 (5)	0 (0)	0 (0)																																																																					
14 (13)	0 (0)	0 (0)																																																																					
0 (0)	0 (0)	0 (0)																																																																					
0 (0)	0 (0)	0 (0)																																																																					
0 (0)	0 (0)	0 (0)																																																																					
4. S Railroad Ave/Driveway/9th Ave	5. S B St/9th Ave																																																																						
<table border="1"> <tr> <td>0 (0)</td> <td>10 (6)</td> <td>0 (0)</td> </tr> <tr> <td>0 (0)</td> <td>0 (0)</td> <td>0 (0)</td> </tr> <tr> <td>0 (0)</td> <td>0 (0)</td> <td>0 (0)</td> </tr> <tr> <td>0 (0)</td> <td>0 (0)</td> <td>0 (0)</td> </tr> <tr> <td>0 (0)</td> <td>0 (0)</td> <td>0 (0)</td> </tr> <tr> <td>3 (11)</td> <td>0 (0)</td> <td>0 (0)</td> </tr> <tr> <td>0 (0)</td> <td>0 (0)</td> <td>0 (0)</td> </tr> <tr> <td>0 (0)</td> <td>0 (0)</td> <td>0 (0)</td> </tr> </table>	0 (0)	10 (6)	0 (0)	0 (0)	0 (0)	0 (0)	0 (0)	0 (0)	0 (0)	0 (0)	0 (0)	0 (0)	0 (0)	0 (0)	0 (0)	3 (11)	0 (0)	0 (0)	0 (0)	0 (0)	0 (0)	0 (0)	0 (0)	0 (0)	<table border="1"> <tr> <td>0 (0)</td> <td>5 (3)</td> <td>0 (0)</td> </tr> <tr> <td>0 (0)</td> <td>5 (3)</td> <td>0 (0)</td> </tr> <tr> <td>0 (0)</td> <td>0 (0)</td> <td>0 (0)</td> </tr> <tr> <td>0 (0)</td> <td>0 (0)</td> <td>0 (0)</td> </tr> <tr> <td>0 (0)</td> <td>0 (0)</td> <td>0 (0)</td> </tr> <tr> <td>0 (0)</td> <td>0 (0)</td> <td>0 (0)</td> </tr> <tr> <td>1 (6)</td> <td>0 (0)</td> <td>0 (0)</td> </tr> <tr> <td>0 (0)</td> <td>0 (0)</td> <td>0 (0)</td> </tr> <tr> <td>0 (0)</td> <td>0 (0)</td> <td>0 (0)</td> </tr> </table>	0 (0)	5 (3)	0 (0)	0 (0)	5 (3)	0 (0)	0 (0)	0 (0)	0 (0)	0 (0)	0 (0)	0 (0)	0 (0)	0 (0)	0 (0)	0 (0)	0 (0)	0 (0)	1 (6)	0 (0)	0 (0)	0 (0)	0 (0)	0 (0)	0 (0)	0 (0)	0 (0)																			
0 (0)	10 (6)	0 (0)																																																																					
0 (0)	0 (0)	0 (0)																																																																					
0 (0)	0 (0)	0 (0)																																																																					
0 (0)	0 (0)	0 (0)																																																																					
0 (0)	0 (0)	0 (0)																																																																					
3 (11)	0 (0)	0 (0)																																																																					
0 (0)	0 (0)	0 (0)																																																																					
0 (0)	0 (0)	0 (0)																																																																					
0 (0)	5 (3)	0 (0)																																																																					
0 (0)	5 (3)	0 (0)																																																																					
0 (0)	0 (0)	0 (0)																																																																					
0 (0)	0 (0)	0 (0)																																																																					
0 (0)	0 (0)	0 (0)																																																																					
0 (0)	0 (0)	0 (0)																																																																					
1 (6)	0 (0)	0 (0)																																																																					
0 (0)	0 (0)	0 (0)																																																																					
0 (0)	0 (0)	0 (0)																																																																					

XX (YY) AM (PM) Project Trip Volumes
 Signalized Intersection
 Stop Sign
 Project Site
 Study Intersection
 Trip Distribution Percentage

Figure 7

Distribution and Assignment of Project Trips



Plus Project VMT

The purpose of this section is to introduce vehicle miles traveled (VMT) and evaluate whether the project fulfills the screening criteria presented in the TIA Guidelines. VMT is a measurement of the amount and distance that a person drives, accounting for the number of passengers within a vehicle. Many interdependent factors affect the amount and distance a person might drive. In particular, the type of built environment affects how many places a person can access within a given distance, time, and cost, using different ways of travel (e.g., private vehicle, public transit, bicycling, walking, etc.). Typically, low-density development located at great distances from other land uses and in areas with few alternatives to the private vehicle provides less access than a location with high density, mix of land uses, and numerous ways of travel. Therefore, low-density development typically generates more VMT per capita compared to a similarly sized development located in urban areas. In general, higher VMT areas are associated with more air pollution, including greenhouse gas emissions, and energy use than lower VMT areas. VMT is calculated by multiplying the number of trips generated by a project by the total distance of each of those trips.

VMT Screening

Although OPR provides recommendations for adopting new VMT analysis guidelines, lead agencies, such as the City of San Mateo, have the final say in designing their methodology to assess VMT and determine a relevant threshold. Lead agencies must prove that their selected analysis methodology aligns with SB 743's goals to promote infill development, reduce greenhouse gases, and reduce VMT. Per the City of San Mateo's TIA guidelines, a project does not need to conduct a detailed VMT analysis if the project is located within a half mile of a high-quality transit as the project can be presumed to have a less-than-significant VMT impact. The project is located within a half mile of the San Mateo Caltrain station and SamTrans Route ECR stop at El Camino Real and 9th Avenue (see Figure 1), which qualifies as a high-quality transit service as defined by San Mateo's TIA guidelines, as it provides 15-minute headways during peak commute hours. In addition to being located within a half mile of a high-quality transit station, the project must meet the following requirements to be presumed to have a less-than-significant VMT impact":

- have a floor area ratio of more than 0.75,
- include no more than the minimum parking required by the City of San Mateo,
- be consistent with the Metropolitan Transportation Commissions' (MTC) Sustainable Communities Strategy (SCS), and
- the project cannot result in a reduction of affordable residential units.

The project has a floor area ratio of 3.0, does not provide more than the minimum parking required by the City of San Mateo, is consistent with MTC's SCS, and the current site does not include any existing residential units. The project is consistent with the SCS's goals of building affordable housing, creating healthy and safe streets by building a complete streets network, and reducing climate emissions by 1) providing land use growth and provides affordable housing near high-quality transit, and 2) promoting alternative modes of travel (walking/biking) through improvements like enhanced sidewalks and bicycle



parking. Therefore, this project would have a less than significant VMT impact in opening year plus project and cumulative plus project conditions due to its proximity to high-quality transit.

Opening Year Plus Project Vehicle Volumes and Level of Service

The net new project trips assignment on were added to the opening year traffic volumes to develop opening year plus project volumes, shown in **Figure 8**.

Table 7 below presents the opening year and opening year plus project LOS and intersection delay in seconds for each study intersection. There are limited changes in LOS in Opening Year Plus Project from Opening Year, and all intersections perform acceptably. The addition of proposed project trips does not result in adverse traffic operations at the study locations. See **Appendix A** for detailed LOS results.

Table 7: Opening Year Plus Project LOS and Delay Results

Intersection	LOS Threshold	Peak Hour	Opening Year		Opening Year Plus Project	
			Delay	LOS	Delay	LOS
1. East 5 th Avenue and South Claremont Street	E	AM	11	B	12	B
		PM	17	C	18	C
2. 9 th Avenue and South Claremont Street	E	AM	14	B	15	B
		PM	12	B	12	B
3. 9 th Avenue and South Railroad Avenue (east)	E	AM	17 (NB)	C	17 (NB)	C
		PM	15 (NB)	B	16 (NB)	C
4. 9 th Avenue and South Railroad Avenue (west)	E	AM	16 (SB)	C	16 (SB)	C
		PM	14 (SB)	B	15 (SB)	B
5. 9 th Avenue and South B Street	Mid-D (45 Secs)	AM	14	B	14	B
		PM	13	B	13	B

Source: Fehr & Peers, 2023



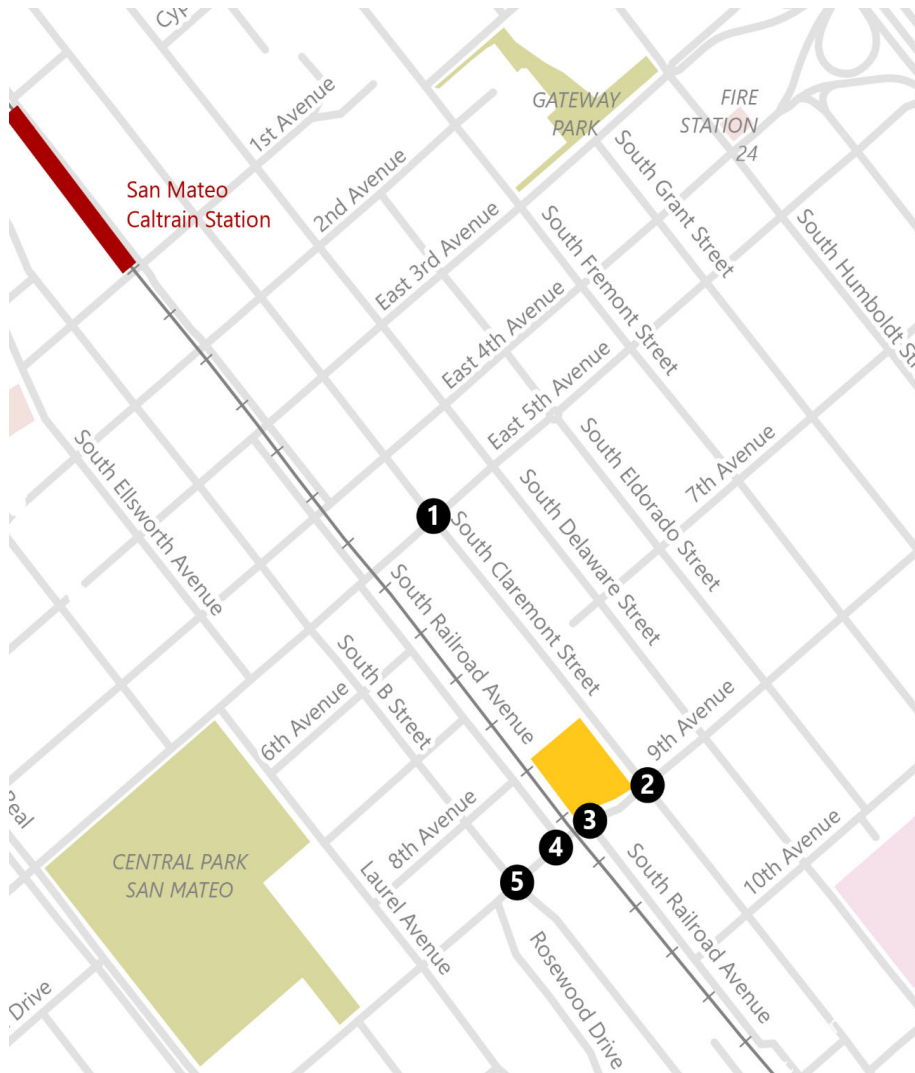

1. S Claremont Ave/E 5th Ave	2. S Claremont Ave/9th Ave	3. Driveway/S Railroad Ave/9th Ave
4. S Railroad Ave/Driveway/9th Ave	5. S B St/9th Ave	

XX (YY) AM (PM) Project Trip Volumes Signalized Intersection Stop Sign
 Project Site Study Intersection

Figure 8
Opening Year Plus Project Vehicle Volumes
Intersection Traffic Volumes, Lane Configurations, and Traffic Controls



Cumulative Conditions

Cumulative conditions reflect estimated future traffic volumes in 2040, approximately 17 years into the future, including the Proposed Project. Future traffic volume forecasts were developed using three different approaches, using estimates from the City of San Mateo Travel Demand Model 2040 General Plan No-Build scenario, which is consistent with a full buildout the San Mateo 2030 General Plan. First, the turning movement volumes for the intersection of 9th Avenue and South B Street were prepared for the General Plan 2040 No-build scenario using the model, and those traffic volumes were extracted for this analysis. Second, South Claremont Street and South Railroad Avenue are not included within the City of San Mateo Travel Demand Model so the traffic growth for study intersections on these roadways was estimated by reviewing traffic growth on the closest parallel roadway of South Delaware Street. The resulting growth rate from the City's Travel Demand Model on South Claremont Street, South Railroad Avenue, and 9th Avenue was an average of two percent per year growth rate to the existing conditions volumes. This represents a conservative approach to estimating future traffic growth on these streets since South Delaware Street is an arterial roadway while South Claremont Street and South Railroad Avenue are collector and local roadways and are therefore likely to experience less growth in traffic due to land use growth elsewhere in the city or region. Finally, the City's Travel Demand Model projects a higher growth rate of three percent per year for the peak direction in traffic (westbound direction in the AM peak period and in both the westbound and eastbound directions in the PM peak period). Two percent growth per year was used for the other legs of the intersection of 5th Avenue and South Claremont Street to reflect traffic growth in the non-peak direction in the City's Travel Demand Model.

The cumulative plus project traffic volumes were compared to opening year plus project volumes and rounded up when necessary to ensure growth in traffic associated with these approved projects were accounted for at the turning movement level. Cumulative no project conditions were created by subtracting the Proposed Project-generated trips from the turning movements.

The resulting cumulative traffic volumes at the study intersections are shown in **Figure 9** and the cumulative plus project volumes are shown in **Figure 10**. Pending development projects in the vicinity of the Proposed Project's study intersections are listed below. The growth from these pending development projects are included in the land use growth assumptions in the City of San Mateo Travel Demand Model 2040 General Plan No-Build scenario. The location of these projects is shown in **Figure 5**.

- Block 20 (500 East 4th Avenue)
- 616 South B Street (Nazareth Vista)
- Bespoke (445 South B Street)



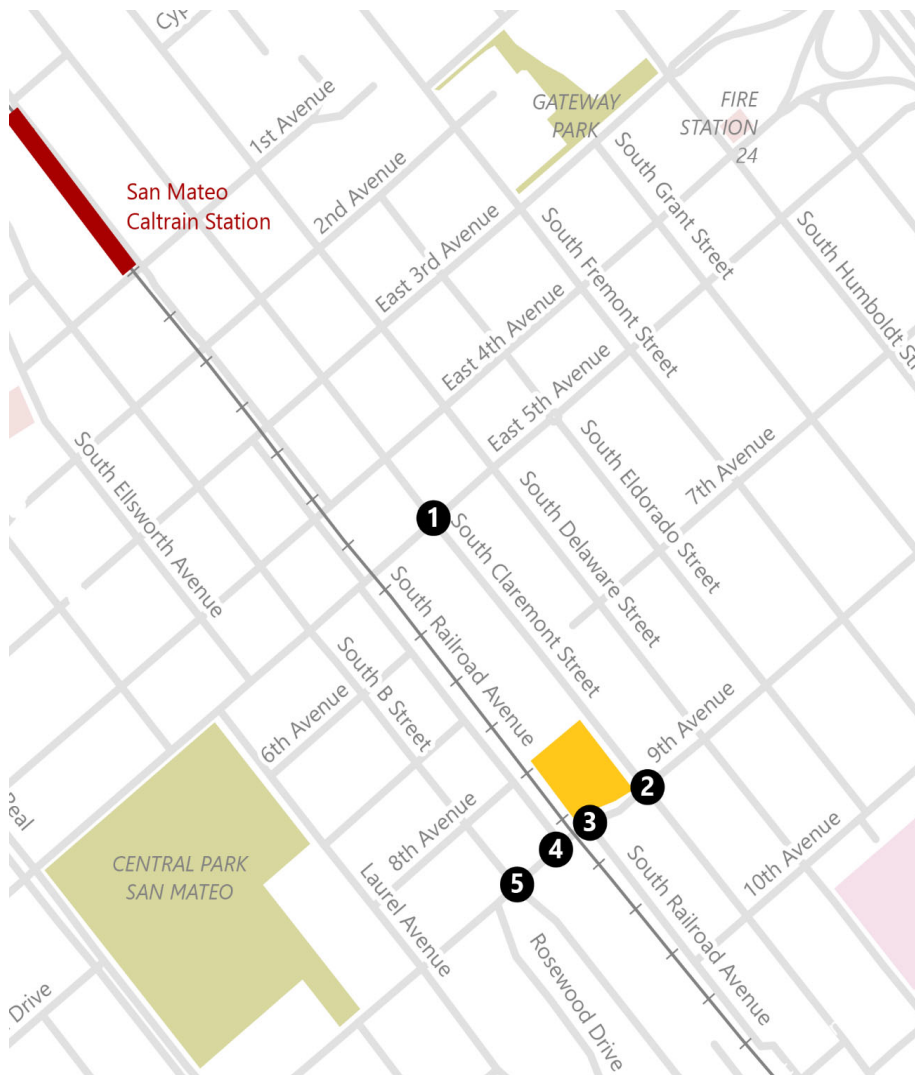

1. S Claremont Ave/E 5th Ave	2. S Claremont Ave/9th Ave	3. Driveway/S Railroad Ave/9th Ave
4. S Railroad Ave/Driveway/9th Ave	5. S B St/9th Ave	

XX (YY) AM (PM) Project Trip Volumes Signalized Intersection Stop Sign
 Project Site Study Intersection

Figure 9
Cumulative Vehicle Volumes
Intersection Traffic Volumes, Lane Configurations, and Traffic Controls



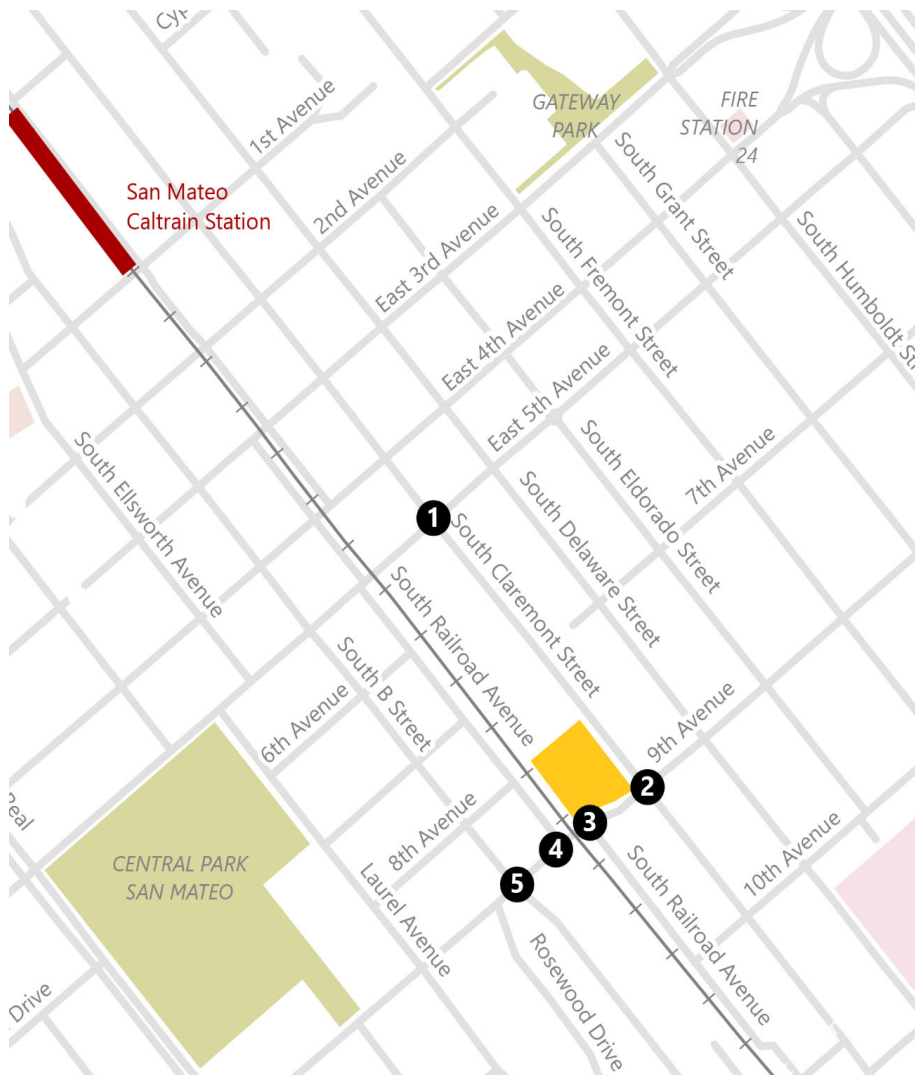

1. S Claremont Ave/E 5th Ave	2. S Claremont Ave/9th Ave	3. Driveway/S Railroad Ave/9th Ave
<p>39 (35) 54 (133) 1 (11)</p> <p>24 (24) 291 (293) 87 (39)</p> <p>47 (64) 208 (377) 23 (37)</p> <p>16 (18) 92 (69) 24 (35)</p>	<p>68 (75) 75 (75) 20 (48)</p> <p>21 (17) 377 (296) 34 (27)</p> <p>48 (47) 344 (405) 103 (97)</p> <p>107 (55) 79 (54) 19 (36)</p>	<p>11 (16) 0 (0) 5 (5)</p> <p>13 (7) 528 (414) 11 (5)</p> <p>20 (14) 466 (520) 64 (63)</p> <p>20 (23) 0 (0) 24 (24)</p>
4. S Railroad Ave/Driveway/9th Ave	5. S B St/9th Ave	
<p>9 (24) 0 (0) 9 (27)</p> <p>556 (453) 3 (0)</p> <p>538 (570) 9 (0)</p> <p>1 (0) 0 (0) 2 (0)</p>	<p>360 (210) 160 (290) 80 (60)</p> <p>123 (187) 193 (220) 250 (70)</p> <p>250 (130) 260 (370) 30 (10)</p> <p>11 (90) 180 (230) 205 (140)</p>	

XX (YY) AM (PM) Project Trip Volumes Signalized Intersection Stop Sign
 Project Site Study Intersection



Figure 10
 Cumulative Plus Project Vehicle Volumes
 Intersection Traffic Volumes, Lane Configurations, and Traffic Controls

Cumulative Intersection Level of Service

Error! Reference source not found. presents the cumulative and cumulative plus project LOS and intersection delay in seconds for each study intersection. See **Appendix A** for detailed LOS results. The intersection delays increase from the existing conditions and opening year conditions to cumulative conditions due to the estimated traffic volume growth at the study intersections. The LOS degraded between existing conditions and cumulative no project conditions at the following intersections:

- East 5th Avenue and South Claremont Street
 - AM Peak Hour: LOS A to LOS B
 - PM Peak Hour: LOS B to LOS C
- 9th Avenue and South Claremont Street
 - AM Peak Hour: LOS B to LOS E
 - PM Peak Hour: LOS B to LOS C
- 9th Avenue and South Railroad Avenue (east)
 - AM Peak Hour: LOS C to LOS D
 - PM Peak Hour: LOS B to LOS C
- 9th Avenue and South Railroad Avenue (west)
 - PM Peak Hour: LOS B to LOS C
- 9th Avenue and South B Street
 - AM Peak Hour: LOS B to LOS C

Although the intersection operations worsened from existing to cumulative no projects conditions, most of the intersections continue to operate acceptably in both the AM and PM peak periods. However, the operations at the intersection of 9th Avenue and South Claremont Street would degrade to unacceptable levels due to the addition of cumulative traffic growth during the AM peak. As noted above, South Claremont Street is not included within the City of San Mateo Travel Demand Model so the cumulative traffic growth was estimated based on the model outputs for the closest parallel roadway of South Delaware Street. This represents a conservative approach to estimating future traffic growth since South Delaware Street is an arterial roadway while South Claremont Street is a collector roadway and is therefore likely to experience less growth in traffic due to land use growth elsewhere in the city or region.

The lower levels of traffic growth that is likely for collector streets such as South Claremont Street would result in better operations compared to what is presented in **Table 8**, potentially reducing delay to acceptable levels. However, the contribution of project trips at this intersection would not have a substantial effect on traffic operations as intersection delay for people driving would not increase by more than four seconds. Therefore, based on the City's threshold for adverse intersection operations outlined in the City's TIA Guidelines, the project would not have an adverse effect to any study intersections under cumulative plus project conditions and no further assessments of future traffic operations is required for this project.



Table 8: Cumulative LOS and Delay Results

Intersection	LOS Threshold	Peak Hour	Existing		Cumulative No Project		Cumulative Plus Project	
			Delay	LOS	Delay	LOS	Delay	LOS
1. East 5th Avenue and South Claremont Street	E	AM	<10	A	13	B	13	B
		PM	11	B	21	C	23	C
2. 9th Avenue and South Claremont Street	E	AM	14	B	42	E	45	E
		PM	12	B	17	C	19	C
3. 9th Avenue and South Railroad Avenue (east)	E	AM	15 (NB)	C	24 (NB)	C	26 (NB)	D
		PM	14 (NB)	B	19 (NB)	C	20 (NB)	C
4. 9th Avenue and South Railroad Avenue (west)	E	AM	16 (SB)	C	22 (SB)	C	23 (SB)	C
		PM	14 (SB)	B	18 (SB)	C	19 (SB)	C
5. 9th Avenue and South B Street	Mid-D (45 Secs)	AM	14	B	18	C	18	C
		PM	13	B	16	B	16	B

Note: Intersections with unacceptable operations are **bolded**

Source: Fehr & Peers, 2023



Additional Transportation Analysis

This section presents an analysis of other transportation issues associated with the project site, including the following:

- Impacts to vehicle, pedestrian & bicycle site access
- Parking
- Hazards and emergency vehicle access
- Neighborhood traffic

The analyses in this section are in accordance with the City of San Mateo's General Plan Circulation Element outlined in the TIA guidelines that requires a non-CEQA local transportation analysis for land use projects that may have an effect on the local street system. The analysis in this section is based on professional judgment in accordance with the standards and methods employed by the traffic engineering community.

Although operational issues are not considered CEQA impacts, they do describe traffic conditions that are relevant to describing the project environment.

Vehicle Site Access and Circulation

The project proposes two new geometric design changes to the surrounding roadway network: 1) the rebuilding of both existing driveways at sidewalk level and 2) the conversion of the existing entry-only driveway at the intersection of 9th Avenue and South Railroad Avenue to allow for two way traffic. The project will add 34 net new vehicle trips to the local roadway network during the AM peak hour and 43 net new vehicle trips during the PM peak hour after subtracting the trips generated by the existing office uses. In total, approximately 63 vehicles would use the project's driveways during the AM peak hour and 72 vehicles would use the project's driveways during the PM peak hour. As summarized in the sections above, the addition of the proposed project trips would not result in any adverse effects on traffic operations at the study locations.

Trips from the north or from US 101 are likely to use the driveway on South Claremont Street to access the project's garage and surface parking, while trips from the south or from El Camino Real are likely to use 9th Avenue driveway. The existing driveway on South Claremont Street allows for both the entry and exit of vehicles, while the driveway on 9th Avenue is currently an entrance only driveway. The project proposes to use both the South Claremont Street and 9th Avenue driveways to enter and exit the project site.

A preliminary site distance assessment was conducted for vehicles turning from the driveways on South Claremont Street and 9th Avenue. The assessment evaluated corner site distance for vehicles exiting the project driveways on South Claremont Street and 9th Avenue, and the stopping site distance for vehicles approaching these driveways on South Claremont Street and 9th Avenue. Stopping site distance is defined



as the distance required by a driver of a vehicle, traveling at a given speed, to bring the vehicle to a stop after an object on the road becomes visible and in advance of reaching the object. Corner site distance is defined as the intersection line of sight maintained between the driver of the vehicle waiting at the crossroad and the driver of an approaching vehicle. For this analysis, a travel speed of 25 miles per hour was used based on our observations of travel behavior through the area. We did not observe hazardous use of this existing drive during our site visit of the project, and we observed low vehicle volumes and speeds on South Claremont Street.

The preliminary site distance assessment shows that the existing driveway on South Claremont Street likely has sufficient corner sight and stopping site distance. Vehicles exiting the driveway would need to nose into the roadway to observe roadway conditions. The corner site and stopping distance on 9th Avenue is sufficient as long as the planned street trees in the planter zone of the sidewalk do not have canopy that blocks the drivers view.

As shown in Error! Reference source not found., garbage facilities will be accessed via the project's off-street loading area in the northwest corner of the site, which can be accessed from the driveway on South Claremont Street

Loading and Curbside Management

There is a marked on-site loading zone in the northwest corner of the project site, in the surface parking area adjacent to the railroad. This loading zone is located next to the project's garbage facility, and garbage collection will occur within the project site. The drive aisles are at least 10 feet wide and provide sufficient internal circulation width for vehicles, including garbage collection trucks, to complete loading and unloading within the project site. Loading and delivery vehicles would enter the project site through the South Claremont driveway and would use the one-way surface parking area to reach the marked on-site loading zone. These vehicles would exit the project site via the 9th Avenue driveway. The surface parking lot area includes a sidewalk for pedestrians accessing vehicles in the project's surface parking lot. The project does not propose modifying the curb destinations and would retain the existing on-street parking surrounding the project site. Therefore, all passenger and vehicle loading would need to occur on-site or use available on-street parking spaces. This would be consistent with the operations of the existing office space.

Freight deliveries for residential uses, including services such as UPS, USPS, Amazon or Doordash, are typically concentrated at the lobby or main entrance where the address to the property is. While there is an off-street loading zone that could accommodate these activities, the loading zone is not located adjacent to the main entrance and therefore infrequent delivery services may instead stop on 9th Avenue. This activity could be accommodated within the existing on-street parking spaces; however, when these are not available the loading activity may occur adjacent to the red curb on 9th Avenue directly in front of the residential lobby and potentially inhibit sight lines for vehicles exiting the driveway on 9th Avenue.



Recommended Improvements

The project sponsor should allocate space on-site adjacent to the main residential entrance or coordinate with the City of San Mateo to designate a loading zone on the 9th Avenue frontage adjacent to the main entrance. These measures would reduce the potential for loading vehicles to interfere with vehicle travel on 9th Avenue.

Pedestrian & Bicycle Site Access and Circulation

Pedestrian Access

The office space has pedestrian entrances on South Claremont Street and via the plaza off of 9th Avenue. The project's residential use is accessed via the building lobby, which is entered through the 9th Avenue pedestrian plaza. The adjacent intersection at 9th Avenue and South Claremont is all-way stop controlled and has marked crosswalks. In general, the proposed project would enhance pedestrian conditions surrounding the project site by widening sidewalks that front the property and providing a 4-foot planted buffer between traffic and pedestrians. The following discussion compares the proposed facilities to the City's policies and guidelines.

Per General Plan Policy C4.5 and C4.6 of the City's General Plan Circulation Element, the City requires as a condition of development project approval the provision of sidewalks and wheelchair ramps where lacking and the repair or replacement of damaged sidewalks. The project would enhance sidewalks on the two blocks fronting the project site with wider sidewalks, street furniture such as benches, street trees, and pedestrian-scale lighting. According to the City of San Mateo's Pedestrian Design Guidelines, Appendix B of the 2012 San Mateo Pedestrian Master Plan¹¹, the recommended minimum sidewalk widths for mixed use developments are 16 feet wide with an eight to 10 foot through zone and a four to six foot planter zone. The City's Municipal Code SMMC 27.48.090 requires 7.5 foot yards along all street frontages for E2 Executive Office zoning district.

The proposed project would meet these guidelines along 9th Avenue or along South Claremont Street. The sidewalks along 9th Avenue and along South Claremont Street will have an overall width of 12 feet, which includes a 8 foot through-zone and a 4 foot planter zone.

As noted in the City's TIA Guidelines, pedestrian safety and accessibility connecting to transit stops or stations in the vicinity of the project site must be assessed. In addition to sidewalks, the City of San Mateo's Pedestrian Design Guidelines provide guidance on the following physical pedestrian facilities that are applicable to the intersection adjacent to the proposed project site. The lack of features consistent with the City's Pedestrian Design Guidelines surrounding the project site could limit pedestrian accessibility to transit stops or stations by creating uncomfortable or unsafe conditions for people walking. The sidewalk obstructions and the lack of a curb ramp at the intersection of 9th Avenue and South Railroad Avenue and South B Street presents obstacles to the most direct ADA-compliant walking

¹¹ *San Mateo Citywide Pedestrian Master Plan*, City of San Mateo & Alta Planning + Design, 2012, p. A13.



route from the project site to Downtown San Mateo amenities and to the SamTrans Route ECR stop at El Camino Real.

Table 9 assesses whether the intersections surrounding the project site are consistent with the guidelines under existing and proposed conditions and provides recommendations to enhance pedestrian comfort and safety based on community feedback and collision data.

Table 9: Existing and Proposed Pedestrian Facilities

Pedestrian Design Feature	Guidelines Summary Applicable to Project ¹	Existing Condition	Proposed Condition	Recommendations
A.11. Curb ramps	Directional (two) curb ramps should be installed at intersections such as those surrounding the project site and along pedestrian routes to transit.	<p>Non directional (single) curb ramps are present on all four corners of the adjacent intersection. The southeast corner of the intersection does not include tactile strips.</p> <p>There is no curb ramp at the intersection of 9th Avenue and South Railroad Avenue, to the west of the project site. This route provides pedestrian access to Route ECR</p>	No change	<p>The project sponsor should include directional curb ramps at the northwest corner of the adjacent intersection.</p> <p>The City could consider the installation of a curb ramp at the intersection of 9th Avenue and South Railroad Avenue to improve pedestrian access to Route ECR.</p>
A.12. Curb extensions	Curb extensions should not encroach into bike lanes but should allow for bus and emergency turning access.	The adjacent intersection does not include curb extensions.	No change	The project sponsor should include a curb extension at the northwest corner of the adjacent intersection to improve pedestrian access and safety.



Pedestrian Design Feature	Guidelines Summary Applicable to Project ¹	Existing Condition	Proposed Condition	Recommendations
A.13 and A.14. Standard and high visibility crosswalks	High visibility continental crosswalks should be prioritized for locations with anticipated high pedestrian activity or a high number of pedestrian-related collisions have occurred.	The adjacent intersection has marked standard crosswalks on all legs of the adjacent intersection.	No change	The project sponsor should include high visibility crosswalks at the adjacent intersection to improve pedestrian access to the South Delaware Street and 10 th Avenue bus stops. The project sponsor should include high visibility crosswalks at the intersection of 9 th Avenue and South Railroad Avenue, to improve pedestrian access to Route ECR.
A.15. Advance stop bars	Advance stop bars should be installed at all controlled intersections.	All four approaches at the adjacent intersection do not have advance stop bars.	No change	The project sponsor should install advance stop bars at the adjacent intersection to increase visibility between drivers and pedestrians.

1. *San Mateo Citywide Pedestrian Master Plan*, City of San Mateo & Alta Planning + Design, 2012, Appendix B: Pedestrian Design Guidelines

2. City of San Mateo Collision Data, 2022,

<https://experience.arcgis.com/experience/8a9f7321d1ce46ffbc0e1f04757efb5f/page/Maps/?views=All-Collisions>

Recommended Improvements

Fehr & Peers recommends the pedestrian facilities from **Table 9** to be consistent with the City of San Mateo’s Pedestrian Design Guidelines. As noted in the Plus Project VMT section, this project qualifies as a transit-oriented project given its location within one-half mile of the Route ECR bus stop at El Camino Real and 9th Avenue and the San Mateo Caltrain station. Providing these recommended features would be consistent with the San Mateo Transit-Oriented Development (TOD) Pedestrian Access Plan¹² toolbox and the improvements provided at similar locations in the TOD Pedestrian Plan, such as along 1st and 2nd Avenues in Downtown San Mateo. As noted in the TOD Pedestrian Access Plan, the City of San Mateo seeks to have development projects that are within one-half mile of high-quality transit construct

¹² *San Mateo Transit-Oriented Development Pedestrian Access Plan*, City of San Mateo & Fehr & Peers, 2022. Access at <https://www.cityofsanmateo.org/4566/TOD-Pedestrian-Access-Plan>.



pedestrian amenities along the project frontage that meet the City's design standards, as described in **Table 9**.

These improvements include a curb extension with directional curb ramps at the northwest corner of the intersection of 9th Avenue and South Claremont Street, high visibility crosswalks to meet City of San Mateo standards, and an off-site curb ramp at the intersection of 9th Avenue and South Railroad Avenue to improve pedestrian access to Route ECR and the San Mateo Caltrain station. 9th Avenue and South Claremont Streets will be important pedestrian access routes to the project, connecting people to high quality transit and amenities in Downtown San Mateo. Although the intersection of 9th Avenue and South Claremont Street has not had any recently reported pedestrian collisions, past conditions may not be reflective of the future conditions as the project replaces automobile-oriented land uses with a mixed-use development will increase pedestrian travel in the area. The off-site curb ramp at the intersection of 9th Avenue and South Railroad Avenue would improve pedestrian access to Route ECR.

Bicycle Access

The project proposes 10 short-term bicycle parking spaces and 132 long-term parking spaces. As shown in the site plan in **Figure 11**, five circular publicly accessible bicycle racks, that hold two bicycles each, are proposed to be placed at street level in the pedestrian plaza at the main entrance located off of 9th Avenue. These 10 spaces fulfill the City requirements for two short-term bicycle spaces for the office use and eight short-term spaces for the residential use. The project's long-term bicycle parking is provided in two separate storage rooms on the first floor of the building adjacent to the main entrance from 9th Avenue. One room, which would provide 84 of the 132 long-term spaces, is accessible through the building lobby. The other room, which provides the remaining 48 long-term spaces, is accessible through the building parking garage. Of these 132 long-term parking spaces, four spaces are provided to meet the requirements for the office use and 128 spaces are provided to meet the residential requirements. Overall, the number of bicycle parking spaces meet the requirements listed in the San Mateo Municipal Code.¹³ Bicycle parking should restrict access to authorized users and provide lockers to ensure people who ride can securely park bicycles for long periods of time. There are no other proposed bicycle facility changes, thus the project would not disrupt existing bicycle facilities in the City.

The City of San Mateo 2020 Bicycle Master Plan has proposed South Claremont Street as a Class III bicycle boulevard. This facility is considered high priority as shown on *Figure 6.1* of the *2020 San Mateo Bicycle Master Plan*¹⁴. The Bicycle Master Plan also proposed an extension to the existing Class II bike lane on 9th Avenue. This extension would improve accessibility to the Class II bicycle lane on South Delaware Street, which is planned to be upgraded to a buffered bike lane in the 2020 Bicycle Master Plan. The Plan also includes a proposed Class II buffered bicycle lane on South B Street. This improved bicycle network would provide additional non-driving options to Downtown San Mateo, the Route ECR bus stops on El Camino Real, and the San Mateo Caltrain station for project residents and employees. 9th Avenue, with its existing and proposed bike lanes, is the best suited route to El Camino Real for residents and employees accessing

¹³ *San Mateo Municipal Code Section 27.64.262(f)(1)(A) Minimum Bicycle Parking Stalls Required*

¹⁴ *San Mateo Bicycle Master Plan, City of San Mateo & Toole Design, 2020, p 60.*



the Route ECR stops, while South Claremont provides the most direct route to the San Mateo Caltrain station to the north. The project would not contain features that would conflict with the proposed bicycle infrastructure within the vicinity of the project.

Transit Access and Circulation

Neither public transit conditions nor public transit access are expected to change with the project. As noted in **Table 6**, the project is estimated to generate approximately 409 daily trips by walking, bicycling, or transit given its proximity to destinations such as downtown San Mateo and high-quality transit services such as Caltrain and SamTrans. New transit trips could be accommodated by existing nearby transit routes and services including SamTrans and Caltrain. SamTrans bus stops are located along El Camino Real and South Delaware Street two to three blocks from the project site. One of the El Camino Real stops, and both of the South Delaware Street stops, do not have a bus shelter. Additionally, both of the South Delaware Street stops do not include seating. Although there are not currently plans to add these features at these specific stops, SamTrans is studying bus stop amenities throughout its system and may include these features at these stops in the future. The pedestrian improvements recommended above and in **Table 9** would ensure that a safe and comfortable path of travel to and from transit is accessible for all users.

Vehicle Parking Conditions

This project will provide a total of 153 parking stalls, including 112 parking stalls for the residential use of the project and 41 stalls for the project's office use. The project's parking garage and surface parking lot can be accessed via the two project driveways located on 9th Avenue and South Claremont Street. 144 parking stalls will be provided via the building's parking garage, while the remaining 9 spaces will be provided as surface parking. As the project is located within the Central Parking and Improvement District but located outside of the Retail Core Subarea of the Downtown Area Plan, the City of San Mateo Municipal Code requires a total of 254 parking stalls for the project, including 180 spaces for the residential use of the project and 74 spaces for the office use of the project.¹⁵ However, due to the recent passage of AB 2097, the project is not required to provide automobile parking due to its proximity to the San Mateo Caltrain station.

Hazards and Emergency Vehicle Access

The proposed project would not create or worsen existing roadway hazards as noted in the above sections. The project does not propose altering the existing roadway network and does not propose new vehicular roadways that would create hazards or impede emergency vehicle access.

¹⁵ City of San Mateo Municipal Code Sections 27.64.100(a)(1) and 27.64.160



Neighborhood Traffic

Due to the relatively small increase in net new vehicle volumes generated by the project, the impact to neighboring streets will be low, given the location of the project site on 9th Avenue, which is an arterial street. The project is located near South Delaware Street and El Camino Real, which are also both designated as arterial streets. Further, the project is adjacent to a collector street: South Claremont Avenue.¹⁶ These roadways provide multiple paths to Downtown San Mateo, freeways, and regional destinations. Therefore, it is not anticipated that project trips will use the neighborhood street network to access local and regional destinations.

¹⁶ *City of San Mateo General Plan Circulation Element: Street Classifications, Figure C-1, November 2011.*



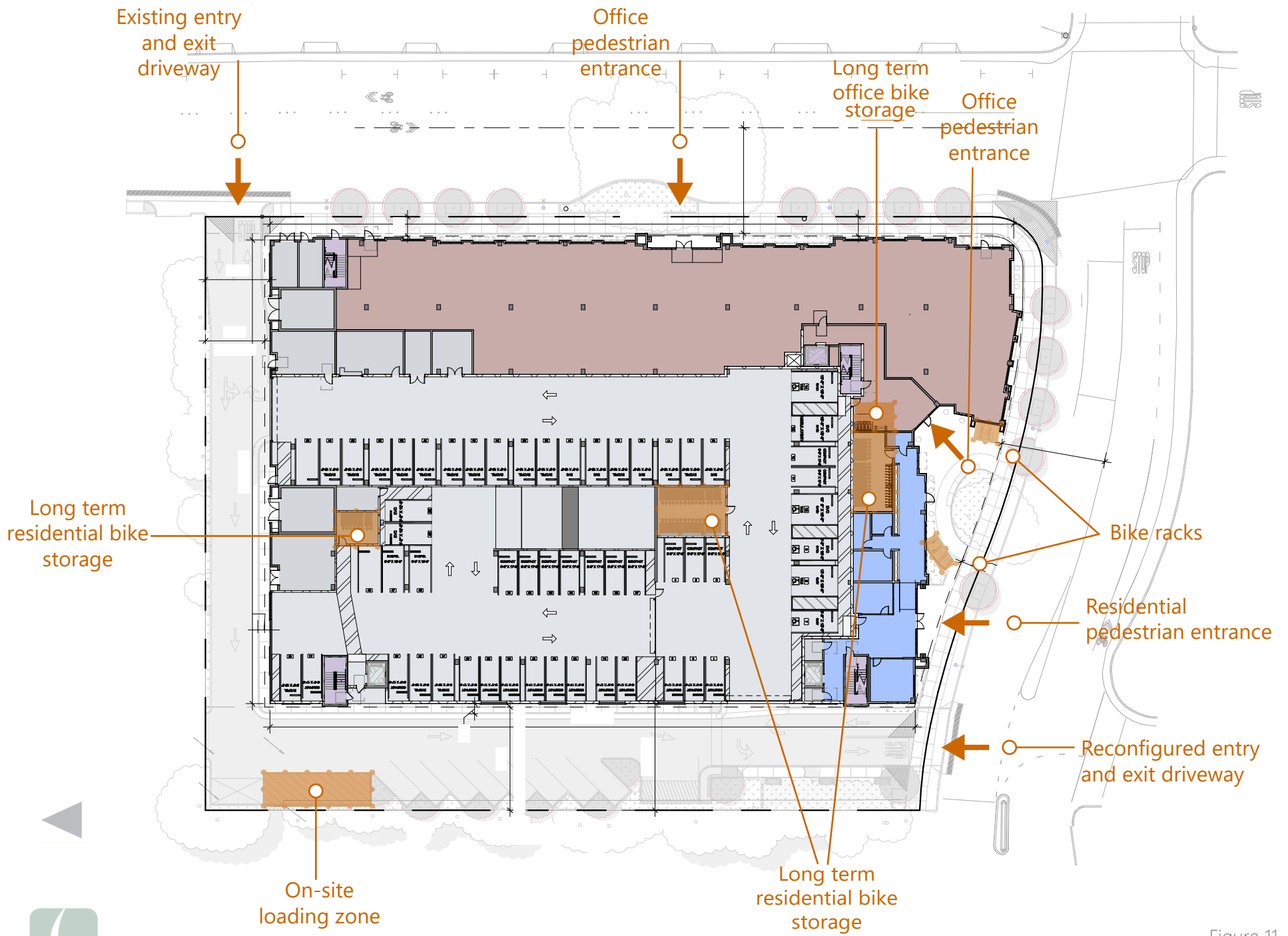

Figure 11
Project Site Plan

Conclusion

The proposed project will not result in CEQA impacts on VMT, bicycle, pedestrian, or transit circulation, or hazards and emergency access. VMT is screened out because of the project's proximity to high-quality transit. The project presents no adverse LOS effects or site circulation issues. The project does not include features that would disrupt these facilities nor generate a substantial number of people that would worsen or create a new impact. The project meets the City's design standards. The following recommended changes to the site plan would ensure consistency with San Mateo standards and best planning practices. The addition of proposed project trips would not result in adverse effects on traffic operations.

Recommendations

- The project sponsor should include directional curb ramps and a curb extension at the northwest corner of the intersection of 9th Avenue and South Claremont Street.
- The project sponsor should include high visibility crosswalks at the intersection of 9th Avenue and South Claremont Street and at the intersection of 9th Avenue and South Railroad Avenue to improve pedestrian access to transit.
- The project sponsor should include advance stop bars at the intersection of 9th Avenue and South Claremont Street to increase visibility between pedestrians and drivers.
- The City should consider the installation of a curb ramp at the intersection of 9th Avenue and South Railroad Avenue.



Appendix A: LOS Calculation Worksheets



Intersection	
Intersection Delay, s/veh	9.3
Intersection LOS	A

Movement	EBL	EBT	EBR	WBL	WBT	WBR	NBL	NBT	NBR	SBL	SBT	SBR
Lane Configurations		↕			↕			↕			↕	
Traffic Vol, veh/h	19	154	17	65	173	18	12	81	18	1	40	7
Future Vol, veh/h	19	154	17	65	173	18	12	81	18	1	40	7
Peak Hour Factor	0.99	0.99	0.99	0.99	0.99	0.99	0.99	0.99	0.99	0.99	0.99	0.99
Heavy Vehicles, %	2	2	2	2	2	2	2	2	2	2	2	2
Mvmt Flow	19	156	17	66	175	18	12	82	18	1	40	7
Number of Lanes	0	1	0	0	1	0	0	1	0	0	1	0

Approach	EB	WB	NB	SB
Opposing Approach	WB	EB	SB	NB
Opposing Lanes	1	1	1	1
Conflicting Approach Left	SB	NB	EB	WB
Conflicting Lanes Left	1	1	1	1
Conflicting Approach Right	NB	SB	WB	EB
Conflicting Lanes Right	1	1	1	1
HCM Control Delay	9.1	9.8	8.9	8.5
HCM LOS	A	A	A	A

Lane	NBLn1	EBLn1	WBLn1	SBLn1
Vol Left, %	11%	10%	25%	2%
Vol Thru, %	73%	81%	68%	83%
Vol Right, %	16%	9%	7%	15%
Sign Control	Stop	Stop	Stop	Stop
Traffic Vol by Lane	111	190	256	48
LT Vol	12	19	65	1
Through Vol	81	154	173	40
RT Vol	18	17	18	7
Lane Flow Rate	112	192	259	48
Geometry Grp	1	1	1	1
Degree of Util (X)	0.154	0.245	0.328	0.068
Departure Headway (Hd)	4.953	4.594	4.562	5.039
Convergence, Y/N	Yes	Yes	Yes	Yes
Cap	721	779	786	707
Service Time	3.004	2.636	2.601	3.096
HCM Lane V/C Ratio	0.155	0.246	0.33	0.068
HCM Control Delay	8.9	9.1	9.8	8.5
HCM Lane LOS	A	A	A	A
HCM 95th-tile Q	0.5	1	1.4	0.2

Intersection												
Intersection Delay, s/veh	14.6											
Intersection LOS	B											

Movement	EBL	EBT	EBR	WBL	WBT	WBR	NBL	NBT	NBR	SBL	SBT	SBR
Lane Configurations		↕			↕			↕			↕	
Traffic Vol, veh/h	36	254	78	25	283	16	80	59	14	15	69	38
Future Vol, veh/h	36	254	78	25	283	16	80	59	14	15	69	38
Peak Hour Factor	0.91	0.91	0.91	0.91	0.91	0.91	0.91	0.91	0.91	0.91	0.91	0.91
Heavy Vehicles, %	2	2	2	2	2	2	2	2	2	2	2	2
Mvmt Flow	40	279	86	27	311	18	88	65	15	16	76	42
Number of Lanes	0	1	0	0	1	0	0	1	0	0	1	0

Approach	EB	WB	NB	SB
Opposing Approach	WB	EB	SB	NB
Opposing Lanes	1	1	1	1
Conflicting Approach Left	SB	NB	EB	WB
Conflicting Lanes Left	1	1	1	1
Conflicting Approach Right	NB	SB	WB	EB
Conflicting Lanes Right	1	1	1	1
HCM Control Delay	16.3	15.1	12	11.1
HCM LOS	C	C	B	B

Lane	NBLn1	EBLn1	WBLn1	SBLn1
Vol Left, %	52%	10%	8%	12%
Vol Thru, %	39%	69%	87%	57%
Vol Right, %	9%	21%	5%	31%
Sign Control	Stop	Stop	Stop	Stop
Traffic Vol by Lane	153	368	324	122
LT Vol	80	36	25	15
Through Vol	59	254	283	69
RT Vol	14	78	16	38
Lane Flow Rate	168	404	356	134
Geometry Grp	1	1	1	1
Degree of Util (X)	0.294	0.602	0.545	0.23
Departure Headway (Hd)	6.3	5.355	5.511	6.183
Convergence, Y/N	Yes	Yes	Yes	Yes
Cap	567	671	652	575
Service Time	4.386	3.419	3.578	4.275
HCM Lane V/C Ratio	0.296	0.602	0.546	0.233
HCM Control Delay	12	16.3	15.1	11.1
HCM Lane LOS	B	C	C	B
HCM 95th-tile Q	1.2	4	3.3	0.9

Intersection												
Int Delay, s/veh	0.7											
Movement	EBL	EBT	EBR	WBL	WBT	WBR	NBL	NBT	NBR	SBL	SBT	SBR
Lane Configurations		↕			↕	↕		↕				
Traffic Vol, veh/h	6	350	51	8	389	4	15	0	18	0	0	0
Future Vol, veh/h	6	350	51	8	389	4	15	0	18	0	0	0
Conflicting Peds, #/hr	21	0	33	0	0	21	0	0	0	0	0	0
Sign Control	Free	Free	Free	Free	Free	Free	Stop	Stop	Stop	Stop	Stop	Stop
RT Channelized	-	-	None	-	-	None	-	-	None	-	-	None
Storage Length	-	-	-	-	-	75	-	-	-	-	-	-
Veh in Median Storage, #	-	0	-	-	0	-	-	0	-	-	0	-
Grade, %	-	0	-	-	0	-	-	0	-	-	0	-
Peak Hour Factor	87	87	87	87	87	87	87	87	87	87	87	87
Heavy Vehicles, %	2	2	2	2	2	2	2	2	2	2	2	2
Mvmt Flow	7	402	59	9	447	5	17	0	21	0	0	0

Major/Minor	Major1			Major2			Minor1		
Conflicting Flow All	473	0	0	494	0	0	947	970	465
Stage 1	-	-	-	-	-	-	479	479	-
Stage 2	-	-	-	-	-	-	468	491	-
Critical Hdwy	4.12	-	-	4.12	-	-	6.42	6.52	6.22
Critical Hdwy Stg 1	-	-	-	-	-	-	5.42	5.52	-
Critical Hdwy Stg 2	-	-	-	-	-	-	5.42	5.52	-
Follow-up Hdwy	2.218	-	-	2.218	-	-	3.518	4.018	3.318
Pot Cap-1 Maneuver	1089	-	-	1070	-	-	290	253	597
Stage 1	-	-	-	-	-	-	623	555	-
Stage 2	-	-	-	-	-	-	630	548	-
Platoon blocked, %	-	-	-	-	-	-	-	-	-
Mov Cap-1 Maneuver	1089	-	-	1036	-	-	275	0	578
Mov Cap-2 Maneuver	-	-	-	-	-	-	275	0	-
Stage 1	-	-	-	-	-	-	598	0	-
Stage 2	-	-	-	-	-	-	622	0	-

Approach	EB			WB			NB		
HCM Control Delay, s	0.1			0.2			15.4		
HCM LOS							C		

Minor Lane/Major Mvmt	NBLn1	EBL	EBT	EBR	WBL	WBT	WBR
Capacity (veh/h)	385	1089	-	-	1036	-	-
HCM Lane V/C Ratio	0.099	0.006	-	-	0.009	-	-
HCM Control Delay (s)	15.4	8.3	0	-	8.5	0	-
HCM Lane LOS	C	A	A	-	A	A	-
HCM 95th %tile Q(veh)	0.3	0	-	-	0	-	-

Intersection												
Int Delay, s/veh	0.3											
Movement	EBL	EBT	EBR	WBL	WBT	WBR	NBL	NBT	NBR	SBL	SBT	SBR
Lane Configurations		↔			↔			↔			↔	
Traffic Vol, veh/h	0	398	5	2	402	0	1	0	2	7	0	7
Future Vol, veh/h	0	398	5	2	402	0	1	0	2	7	0	7
Conflicting Peds, #/hr	0	0	29	29	0	0	0	0	0	0	0	0
Sign Control	Free	Free	Free	Free	Free	Free	Stop	Stop	Stop	Stop	Stop	Stop
RT Channelized	-	-	None	-	-	None	-	-	None	-	-	None
Storage Length	-	-	-	-	-	-	-	-	-	-	-	-
Veh in Median Storage, #	-	0	-	-	0	-	-	0	-	-	0	-
Grade, %	-	0	-	-	0	-	-	0	-	-	0	-
Peak Hour Factor	86	86	86	86	86	86	86	86	86	86	86	86
Heavy Vehicles, %	2	2	2	2	2	2	2	2	2	2	2	2
Mvmt Flow	0	463	6	2	467	0	1	0	2	8	0	8

Major/Minor	Major1			Major2			Minor1			Minor2		
Conflicting Flow All	-	0	0	498	0	0	970	966	495	938	969	467
Stage 1	-	-	-	-	-	-	495	495	-	471	471	-
Stage 2	-	-	-	-	-	-	475	471	-	467	498	-
Critical Hdwy	-	-	-	4.12	-	-	7.12	6.52	6.22	7.12	6.52	6.22
Critical Hdwy Stg 1	-	-	-	-	-	-	6.12	5.52	-	6.12	5.52	-
Critical Hdwy Stg 2	-	-	-	-	-	-	6.12	5.52	-	6.12	5.52	-
Follow-up Hdwy	-	-	-	2.218	-	-	3.518	4.018	3.318	3.518	4.018	3.318
Pot Cap-1 Maneuver	0	-	-	1066	-	0	233	255	575	244	254	596
Stage 1	0	-	-	-	-	0	556	546	-	573	560	-
Stage 2	0	-	-	-	-	0	570	560	-	576	544	-
Platoon blocked, %	-	-	-	-	-	-	-	-	-	-	-	-
Mov Cap-1 Maneuver	-	-	-	1037	-	-	223	247	559	243	246	596
Mov Cap-2 Maneuver	-	-	-	-	-	-	223	247	-	243	246	-
Stage 1	-	-	-	-	-	-	556	531	-	573	558	-
Stage 2	-	-	-	-	-	-	561	558	-	574	529	-

Approach	EB	WB	NB	SB
HCM Control Delay, s	0	0	14.8	16
HCM LOS			B	C

Minor Lane/Major Mvmt	NBLn1	EBT	EBR	WBL	WBT	SBLn1
Capacity (veh/h)	372	-	-	1037	-	345
HCM Lane V/C Ratio	0.009	-	-	0.002	-	0.047
HCM Control Delay (s)	14.8	-	-	8.5	0	16
HCM Lane LOS	B	-	-	A	A	C
HCM 95th %tile Q(veh)	0	-	-	0	-	0.1

HCM 6th Signalized Intersection Summary
5: S B St & 9th Ave

Existing AM
06/09/2023



Movement	EBL	EBT	EBR	WBL	WBT	WBR	NBL	NBT	NBR	SBL	SBT	SBR
Lane Configurations		↔		↔	↔		↔	↔		↔	↔	
Traffic Volume (veh/h)	22	212	5	81	268	61	11	61	144	47	45	16
Future Volume (veh/h)	22	212	5	81	268	61	11	61	144	47	45	16
Initial Q (Qb), veh	0	0	0	0	0	0	0	0	0	0	0	0
Ped-Bike Adj(A_pbT)	0.99		0.98	0.99		0.95	0.99		0.96	0.99		0.96
Parking Bus, Adj	1.00	1.00	1.00	1.00	1.00	1.00	1.00	1.00	1.00	1.00	1.00	1.00
Work Zone On Approach		No			No			No			No	
Adj Sat Flow, veh/h/ln	1870	1870	1870	1870	1870	1870	1870	1870	1870	1870	1870	1870
Adj Flow Rate, veh/h	25	244	5	93	308	56	13	70	77	54	52	8
Peak Hour Factor	0.87	0.87	0.87	0.87	0.87	0.87	0.87	0.87	0.87	0.87	0.87	0.87
Percent Heavy Veh, %	2	2	2	2	2	2	2	2	2	2	2	2
Cap, veh/h	92	682	13	555	616	112	705	371	409	620	733	113
Arrive On Green	0.40	0.40	0.40	0.40	0.40	0.40	0.47	0.47	0.47	0.47	0.47	0.47
Sat Flow, veh/h	76	1690	33	1115	1526	277	1325	797	877	1227	1574	242
Grp Volume(v), veh/h	274	0	0	93	0	364	13	0	147	54	0	60
Grp Sat Flow(s),veh/h/ln	1798	0	0	1115	0	1803	1325	0	1674	1227	0	1816
Q Serve(g_s), s	0.0	0.0	0.0	0.0	0.0	9.7	0.4	0.0	3.3	1.7	0.0	1.2
Cycle Q Clear(g_c), s	6.6	0.0	0.0	3.8	0.0	9.7	1.5	0.0	3.3	5.0	0.0	1.2
Prop In Lane	0.09		0.02	1.00		0.15	1.00		0.52	1.00		0.13
Lane Grp Cap(c), veh/h	787	0	0	555	0	728	705	0	780	620	0	846
V/C Ratio(X)	0.35	0.00	0.00	0.17	0.00	0.50	0.02	0.00	0.19	0.09	0.00	0.07
Avail Cap(c_a), veh/h	787	0	0	555	0	728	705	0	780	620	0	846
HCM Platoon Ratio	1.00	1.00	1.00	1.00	1.00	1.00	1.00	1.00	1.00	1.00	1.00	1.00
Upstream Filter(I)	1.00	0.00	0.00	1.00	0.00	1.00	1.00	0.00	1.00	1.00	0.00	1.00
Uniform Delay (d), s/veh	13.4	0.0	0.0	12.6	0.0	14.3	9.9	0.0	10.1	11.5	0.0	9.5
Incr Delay (d2), s/veh	1.2	0.0	0.0	0.7	0.0	2.4	0.0	0.0	0.5	0.3	0.0	0.2
Initial Q Delay(d3),s/veh	0.0	0.0	0.0	0.0	0.0	0.0	0.0	0.0	0.0	0.0	0.0	0.0
%ile BackOfQ(50%),veh/ln	2.8	0.0	0.0	0.9	0.0	4.0	0.1	0.0	1.2	0.5	0.0	0.5
Unsig. Movement Delay, s/veh												
LnGrp Delay(d),s/veh	14.6	0.0	0.0	13.2	0.0	16.8	10.0	0.0	10.6	11.8	0.0	9.7
LnGrp LOS	B	A	A	B	A	B	A	A	B	B	A	A
Approach Vol, veh/h		274			457			160				114
Approach Delay, s/veh		14.6			16.1			10.6				10.7
Approach LOS		B			B			B				B
Timer - Assigned Phs		2		4		6		8				
Phs Duration (G+Y+Rc), s		30.2		34.2		30.2		34.2				
Change Period (Y+Rc), s		* 4.2		* 4.2		* 4.2		* 4.2				
Max Green Setting (Gmax), s		* 26		* 30		* 26		* 30				
Max Q Clear Time (g_c+I1), s		8.6		5.3		11.7		7.0				
Green Ext Time (p_c), s		0.3		1.2		0.4		0.6				

Intersection Summary

HCM 6th Ctrl Delay	14.2
HCM 6th LOS	B

Notes

* HCM 6th computational engine requires equal clearance times for the phases crossing the barrier.

Intersection	
Intersection Delay, s/veh	10.7
Intersection LOS	B

Movement	EBL	EBT	EBR	WBL	WBT	WBR	NBL	NBT	NBR	SBL	SBT	SBR
Lane Configurations		↕			↕			↕			↕	
Traffic Vol, veh/h	36	233	22	27	194	18	11	56	21	8	61	8
Future Vol, veh/h	36	233	22	27	194	18	11	56	21	8	61	8
Peak Hour Factor	0.88	0.88	0.88	0.88	0.88	0.88	0.88	0.88	0.88	0.88	0.88	0.88
Heavy Vehicles, %	2	2	2	2	2	2	2	2	2	2	2	2
Mvmt Flow	41	265	25	31	220	20	13	64	24	9	69	9
Number of Lanes	0	1	0	0	1	0	0	1	0	0	1	0

Approach	EB	WB	NB	SB
Opposing Approach	WB	EB	SB	NB
Opposing Lanes	1	1	1	1
Conflicting Approach Left	SB	NB	EB	WB
Conflicting Lanes Left	1	1	1	1
Conflicting Approach Right	NB	SB	WB	EB
Conflicting Lanes Right	1	1	1	1
HCM Control Delay	11.5	10.6	9.4	9.4
HCM LOS	B	B	A	A

Lane	NBLn1	EBLn1	WBLn1	SBLn1
Vol Left, %	12%	12%	11%	10%
Vol Thru, %	64%	80%	81%	79%
Vol Right, %	24%	8%	8%	10%
Sign Control	Stop	Stop	Stop	Stop
Traffic Vol by Lane	88	291	239	77
LT Vol	11	36	27	8
Through Vol	56	233	194	61
RT Vol	21	22	18	8
Lane Flow Rate	100	331	272	88
Geometry Grp	1	1	1	1
Degree of Util (X)	0.151	0.435	0.362	0.135
Departure Headway (Hd)	5.444	4.732	4.797	5.543
Convergence, Y/N	Yes	Yes	Yes	Yes
Cap	662	754	741	650
Service Time	3.448	2.814	2.883	3.547
HCM Lane V/C Ratio	0.151	0.439	0.367	0.135
HCM Control Delay	9.4	11.5	10.6	9.4
HCM Lane LOS	A	B	B	A
HCM 95th-tile Q	0.5	2.2	1.7	0.5

Intersection

Intersection Delay, s/veh	12
Intersection LOS	B

Movement	EBL	EBT	EBR	WBL	WBT	WBR	NBL	NBT	NBR	SBL	SBT	SBR
Lane Configurations		↕			↕			↕			↕	
Traffic Vol, veh/h	35	291	66	20	221	13	41	40	27	22	45	43
Future Vol, veh/h	35	291	66	20	221	13	41	40	27	22	45	43
Peak Hour Factor	0.97	0.97	0.97	0.97	0.97	0.97	0.97	0.97	0.97	0.97	0.97	0.97
Heavy Vehicles, %	2	2	2	2	2	2	2	2	2	2	2	2
Mvmt Flow	36	300	68	21	228	13	42	41	28	23	46	44
Number of Lanes	0	1	0	0	1	0	0	1	0	0	1	0

Approach	EB	WB	NB	SB
Opposing Approach	WB	EB	SB	NB
Opposing Lanes	1	1	1	1
Conflicting Approach Left	SB	NB	EB	WB
Conflicting Lanes Left	1	1	1	1
Conflicting Approach Right	NB	SB	WB	EB
Conflicting Lanes Right	1	1	1	1
HCM Control Delay	13.7	11.2	10	9.9
HCM LOS	B	B	A	A

Lane	NBLn1	EBLn1	WBLn1	SBLn1
Vol Left, %	38%	9%	8%	20%
Vol Thru, %	37%	74%	87%	41%
Vol Right, %	25%	17%	5%	39%
Sign Control	Stop	Stop	Stop	Stop
Traffic Vol by Lane	108	392	254	110
LT Vol	41	35	20	22
Through Vol	40	291	221	45
RT Vol	27	66	13	43
Lane Flow Rate	111	404	262	113
Geometry Grp	1	1	1	1
Degree of Util (X)	0.177	0.55	0.372	0.177
Departure Headway (Hd)	5.735	4.901	5.118	5.614
Convergence, Y/N	Yes	Yes	Yes	Yes
Cap	625	740	702	638
Service Time	3.778	2.901	3.151	3.656
HCM Lane V/C Ratio	0.178	0.546	0.373	0.177
HCM Control Delay	10	13.7	11.2	9.9
HCM Lane LOS	A	B	B	A
HCM 95th-tile Q	0.6	3.4	1.7	0.6

Intersection												
Int Delay, s/veh	0.7											
Movement	EBL	EBT	EBR	WBL	WBT	WBR	NBL	NBT	NBR	SBL	SBT	SBR
Lane Configurations		↕			↕	↕		↕				
Traffic Vol, veh/h	1	374	42	4	300	1	17	0	18	0	0	0
Future Vol, veh/h	1	374	42	4	300	1	17	0	18	0	0	0
Conflicting Peds, #/hr	28	0	32	32	0	28	0	0	0	0	0	0
Sign Control	Free	Free	Free	Free	Free	Free	Stop	Stop	Stop	Stop	Stop	Stop
RT Channelized	-	-	None	-	-	None	-	-	None	-	-	None
Storage Length	-	-	-	-	-	75	-	-	-	-	-	-
Veh in Median Storage, #	-	0	-	-	0	-	-	0	-	-	0	-
Grade, %	-	0	-	-	0	-	-	0	-	-	0	-
Peak Hour Factor	94	94	94	94	94	94	94	94	94	94	94	94
Heavy Vehicles, %	2	2	2	2	2	2	2	2	2	2	2	2
Mvmt Flow	1	398	45	4	319	1	18	0	19	0	0	0

Major/Minor	Major1			Major2			Minor1		
Conflicting Flow All	348	0	0	475	0	0	783	811	453
Stage 1	-	-	-	-	-	-	455	455	-
Stage 2	-	-	-	-	-	-	328	356	-
Critical Hdwy	4.12	-	-	4.12	-	-	6.42	6.52	6.22
Critical Hdwy Stg 1	-	-	-	-	-	-	5.42	5.52	-
Critical Hdwy Stg 2	-	-	-	-	-	-	5.42	5.52	-
Follow-up Hdwy	2.218	-	-	2.218	-	-	3.518	4.018	3.318
Pot Cap-1 Maneuver	1211	-	-	1087	-	-	362	313	607
Stage 1	-	-	-	-	-	-	639	569	-
Stage 2	-	-	-	-	-	-	730	629	-
Platoon blocked, %		-	-		-	-			
Mov Cap-1 Maneuver	1211	-	-	1054	-	-	349	0	589
Mov Cap-2 Maneuver	-	-	-	-	-	-	349	0	-
Stage 1	-	-	-	-	-	-	619	0	-
Stage 2	-	-	-	-	-	-	726	0	-

Approach	EB			WB			NB		
HCM Control Delay, s	0			0.1			13.9		
HCM LOS							B		

Minor Lane/Major Mvmt	NBLn1	EBL	EBT	EBR	WBL	WBT	WBR
Capacity (veh/h)	442	1211	-	-	1054	-	-
HCM Lane V/C Ratio	0.084	0.001	-	-	0.004	-	-
HCM Control Delay (s)	13.9	8	0	-	8.4	0	-
HCM Lane LOS	B	A	A	-	A	A	-
HCM 95th %tile Q(veh)	0.3	0	-	-	0	-	-

Intersection												
Int Delay, s/veh	0.7											
Movement	EBL	EBT	EBR	WBL	WBT	WBR	NBL	NBT	NBR	SBL	SBT	SBR
Lane Configurations		↔			↔			↔			↔	
Traffic Vol, veh/h	0	397	0	0	317	0	0	0	0	20	0	18
Future Vol, veh/h	0	397	0	0	317	0	0	0	0	20	0	18
Conflicting Peds, #/hr	0	0	27	27	0	0	0	0	0	0	0	0
Sign Control	Free	Free	Free	Free	Free	Free	Stop	Stop	Stop	Stop	Stop	Stop
RT Channelized	-	-	None	-	-	None	-	-	None	-	-	None
Storage Length	-	-	-	-	-	-	-	-	-	-	-	-
Veh in Median Storage, #	-	0	-	-	0	-	-	0	-	-	0	-
Grade, %	-	0	-	-	0	-	-	0	-	-	0	-
Peak Hour Factor	93	93	93	93	93	93	93	93	93	93	93	93
Heavy Vehicles, %	2	2	2	2	2	2	2	2	2	2	2	2
Mvmt Flow	0	427	0	0	341	0	0	0	0	22	0	19

Major/Minor	Major1			Major2			Minor1			Minor2		
Conflicting Flow All	-	0	0	454	0	0	805	795	454	768	795	341
Stage 1	-	-	-	-	-	-	454	454	-	341	341	-
Stage 2	-	-	-	-	-	-	351	341	-	427	454	-
Critical Hdwy	-	-	-	4.12	-	-	7.12	6.52	6.22	7.12	6.52	6.22
Critical Hdwy Stg 1	-	-	-	-	-	-	6.12	5.52	-	6.12	5.52	-
Critical Hdwy Stg 2	-	-	-	-	-	-	6.12	5.52	-	6.12	5.52	-
Follow-up Hdwy	-	-	-	2.218	-	-	3.518	4.018	3.318	3.518	4.018	3.318
Pot Cap-1 Maneuver	0	-	-	1107	-	0	301	320	606	319	320	701
Stage 1	0	-	-	-	-	0	586	569	-	674	639	-
Stage 2	0	-	-	-	-	0	666	639	-	606	569	-
Platoon blocked, %	-	-	-	-	-	-	-	-	-	-	-	-
Mov Cap-1 Maneuver	-	-	-	1079	-	-	285	312	590	319	312	701
Mov Cap-2 Maneuver	-	-	-	-	-	-	285	312	-	319	312	-
Stage 1	-	-	-	-	-	-	586	554	-	674	639	-
Stage 2	-	-	-	-	-	-	648	639	-	606	554	-

Approach	EB	WB	NB	SB
HCM Control Delay, s	0	0	0	14.2
HCM LOS			A	B

Minor Lane/Major Mvmt	NBLn1	EBT	EBR	WBL	WBT	SBLn1
Capacity (veh/h)	-	-	-	1079	-	430
HCM Lane V/C Ratio	-	-	-	-	-	0.095
HCM Control Delay (s)	0	-	-	0	-	14.2
HCM Lane LOS	A	-	-	A	-	B
HCM 95th %tile Q(veh)	-	-	-	0	-	0.3

HCM 6th Signalized Intersection Summary
5: S B St & 9th Ave

Existing PM
06/09/2023



Movement	EBL	EBT	EBR	WBL	WBT	WBR	NBL	NBT	NBR	SBL	SBT	SBR
Lane Configurations		↔		↔	↔		↔	↔		↔	↔	
Traffic Volume (veh/h)	26	201	11	85	183	67	6	75	124	72	49	33
Future Volume (veh/h)	26	201	11	85	183	67	6	75	124	72	49	33
Initial Q (Qb), veh	0	0	0	0	0	0	0	0	0	0	0	0
Ped-Bike Adj(A_pbT)	0.97		0.93	0.97		0.93	0.98		0.95	0.98		0.95
Parking Bus, Adj	1.00	1.00	1.00	1.00	1.00	1.00	1.00	1.00	1.00	1.00	1.00	1.00
Work Zone On Approach		No			No			No			No	
Adj Sat Flow, veh/h/ln	1870	1870	1870	1870	1870	1870	1870	1870	1870	1870	1870	1870
Adj Flow Rate, veh/h	28	216	9	91	197	49	6	81	61	77	53	16
Peak Hour Factor	0.93	0.93	0.93	0.93	0.93	0.93	0.93	0.93	0.93	0.93	0.93	0.93
Percent Heavy Veh, %	2	2	2	2	2	2	2	2	2	2	2	2
Cap, veh/h	102	655	26	563	574	143	690	451	339	621	634	192
Arrive On Green	0.40	0.40	0.40	0.40	0.40	0.40	0.47	0.47	0.47	0.47	0.47	0.47
Sat Flow, veh/h	98	1622	63	1119	1421	353	1301	967	728	1222	1362	411
Grp Volume(v), veh/h	253	0	0	91	0	246	6	0	142	77	0	69
Grp Sat Flow(s),veh/h/ln	1784	0	0	1119	0	1774	1301	0	1696	1222	0	1773
Q Serve(g_s), s	0.0	0.0	0.0	0.0	0.0	6.2	0.2	0.0	3.1	2.5	0.0	1.4
Cycle Q Clear(g_c), s	6.1	0.0	0.0	3.4	0.0	6.2	1.6	0.0	3.1	5.7	0.0	1.4
Prop In Lane	0.11		0.04	1.00		0.20	1.00		0.43	1.00		0.23
Lane Grp Cap(c), veh/h	782	0	0	563	0	716	690	0	790	621	0	826
V/C Ratio(X)	0.32	0.00	0.00	0.16	0.00	0.34	0.01	0.00	0.18	0.12	0.00	0.08
Avail Cap(c_a), veh/h	782	0	0	563	0	716	690	0	790	621	0	826
HCM Platoon Ratio	1.00	1.00	1.00	1.00	1.00	1.00	1.00	1.00	1.00	1.00	1.00	1.00
Upstream Filter(I)	1.00	0.00	0.00	1.00	0.00	1.00	1.00	0.00	1.00	1.00	0.00	1.00
Uniform Delay (d), s/veh	13.3	0.0	0.0	12.5	0.0	13.3	10.0	0.0	10.0	11.7	0.0	9.6
Incr Delay (d2), s/veh	1.1	0.0	0.0	0.6	0.0	1.3	0.0	0.0	0.5	0.4	0.0	0.2
Initial Q Delay(d3),s/veh	0.0	0.0	0.0	0.0	0.0	0.0	0.0	0.0	0.0	0.0	0.0	0.0
%ile BackOfQ(50%),veh/ln	2.5	0.0	0.0	0.9	0.0	2.5	0.0	0.0	1.1	0.7	0.0	0.5
Unsig. Movement Delay, s/veh												
LnGrp Delay(d),s/veh	14.4	0.0	0.0	13.1	0.0	14.6	10.0	0.0	10.5	12.1	0.0	9.8
LnGrp LOS	B	A	A	B	A	B	B	A	B	B	A	A
Approach Vol, veh/h		253			337			148				146
Approach Delay, s/veh		14.4			14.2			10.5				11.0
Approach LOS		B			B			B				B
Timer - Assigned Phs		2		4		6		8				
Phs Duration (G+Y+Rc), s		30.2		34.2		30.2		34.2				
Change Period (Y+Rc), s		* 4.2		* 4.2		* 4.2		* 4.2				
Max Green Setting (Gmax), s		* 26		* 30		* 26		* 30				
Max Q Clear Time (g_c+I1), s		8.1		5.1		8.2		7.7				
Green Ext Time (p_c), s		0.3		1.1		0.3		0.8				

Intersection Summary

HCM 6th Ctrl Delay	13.1
HCM 6th LOS	B

Notes

* HCM 6th computational engine requires equal clearance times for the phases crossing the barrier.

Intersection	
Intersection Delay, s/veh	11.4
Intersection LOS	B

Movement	EBL	EBT	EBR	WBL	WBT	WBR	NBL	NBT	NBR	SBL	SBT	SBR
Lane Configurations		↕			↕			↕			↕	
Traffic Vol, veh/h	47	208	17	65	291	20	6	81	17	0	41	39
Future Vol, veh/h	47	208	17	65	291	20	6	81	17	0	41	39
Peak Hour Factor	0.99	0.99	0.99	0.99	0.99	0.99	0.99	0.99	0.99	0.99	0.99	0.99
Heavy Vehicles, %	2	2	2	2	2	2	2	2	2	2	2	2
Mvmt Flow	47	210	17	66	294	20	6	82	17	0	41	39
Number of Lanes	0	1	0	0	1	0	0	1	0	0	1	0

Approach	EB	WB	NB	SB
Opposing Approach	WB	EB	SB	NB
Opposing Lanes	1	1	1	1
Conflicting Approach Left	SB	NB	EB	WB
Conflicting Lanes Left	1	1	1	1
Conflicting Approach Right	NB	SB	WB	EB
Conflicting Lanes Right	1	1	1	1
HCM Control Delay	10.9	12.6	9.7	9.2
HCM LOS	B	B	A	A

Lane	NBLn1	EBLn1	WBLn1	SBLn1
Vol Left, %	6%	17%	17%	0%
Vol Thru, %	78%	76%	77%	51%
Vol Right, %	16%	6%	5%	49%
Sign Control	Stop	Stop	Stop	Stop
Traffic Vol by Lane	104	272	376	80
LT Vol	6	47	65	0
Through Vol	81	208	291	41
RT Vol	17	17	20	39
Lane Flow Rate	105	275	380	81
Geometry Grp	1	1	1	1
Degree of Util (X)	0.163	0.372	0.502	0.122
Departure Headway (Hd)	5.598	4.871	4.757	5.444
Convergence, Y/N	Yes	Yes	Yes	Yes
Cap	644	728	748	662
Service Time	3.601	2.966	2.845	3.448
HCM Lane V/C Ratio	0.163	0.378	0.508	0.122
HCM Control Delay	9.7	10.9	12.6	9.2
HCM Lane LOS	A	B	B	A
HCM 95th-tile Q	0.6	1.7	2.8	0.4

Intersection

Intersection Delay, s/veh 14.3
Intersection LOS B

Movement	EBL	EBT	EBR	WBL	WBT	WBR	NBL	NBT	NBR	SBL	SBT	SBR
Lane Configurations		↕			↕			↕			↕	
Traffic Vol, veh/h	35	256	76	25	279	10	80	59	14	15	69	39
Future Vol, veh/h	35	256	76	25	279	10	80	59	14	15	69	39
Peak Hour Factor	0.91	0.91	0.91	0.91	0.91	0.91	0.91	0.91	0.91	0.91	0.91	0.91
Heavy Vehicles, %	2	2	2	2	2	2	2	2	2	2	2	2
Mvmt Flow	38	281	84	27	307	11	88	65	15	16	76	43
Number of Lanes	0	1	0	0	1	0	0	1	0	0	1	0

Approach	EB	WB	NB	SB
Opposing Approach	WB	EB	SB	NB
Opposing Lanes	1	1	1	1
Conflicting Approach Left SB		NB	EB	WB
Conflicting Lanes Left	1	1	1	1
Conflicting Approach Right NB		SB	WB	EB
Conflicting Lanes Right	1	1	1	1
HCM Control Delay	16.1	14.7	12	11.1
HCM LOS	C	B	B	B

Lane	NBLn1	EBLn1	WBLn1	SBLn1
Vol Left, %	52%	10%	8%	12%
Vol Thru, %	39%	70%	89%	56%
Vol Right, %	9%	21%	3%	32%
Sign Control	Stop	Stop	Stop	Stop
Traffic Vol by Lane	153	367	314	123
LT Vol	80	35	25	15
Through Vol	59	256	279	69
RT Vol	14	76	10	39
Lane Flow Rate	168	403	345	135
Geometry Grp	1	1	1	1
Degree of Util (X)	0.293	0.598	0.529	0.231
Departure Headway (Hd)	6.266	5.338	5.517	6.143
Convergence, Y/N	Yes	Yes	Yes	Yes
Cap	570	674	649	580
Service Time	4.352	3.404	3.585	4.233
HCM Lane V/C Ratio	0.295	0.598	0.532	0.233
HCM Control Delay	12	16.1	14.7	11.1
HCM Lane LOS	B	C	B	B
HCM 95th-tile Q	1.2	4	3.1	0.9

Intersection												
Int Delay, s/veh	0.8											
Movement	EBL	EBT	EBR	WBL	WBT	WBR	NBL	NBT	NBR	SBL	SBT	SBR
Lane Configurations		↕			↕	↕		↕			↕	
Traffic Vol, veh/h	6	349	51	7	387	4	15	0	18	0	0	0
Future Vol, veh/h	6	349	51	7	387	4	15	0	18	0	0	0
Conflicting Peds, #/hr	21	0	33	0	0	21	0	0	0	0	0	0
Sign Control	Free	Free	Free	Free	Free	Free	Stop	Stop	Stop	Stop	Stop	Stop
RT Channelized	-	-	None	-	-	None	-	-	None	-	-	None
Storage Length	-	-	-	-	-	75	-	-	-	-	-	-
Veh in Median Storage, #	-	0	-	-	0	-	-	0	-	-	0	-
Grade, %	-	0	-	-	0	-	-	0	-	-	0	-
Peak Hour Factor	87	87	87	87	87	87	87	87	87	87	87	87
Heavy Vehicles, %	2	2	2	2	2	2	2	2	2	2	2	2
Mvmt Flow	7	401	59	8	445	5	17	0	21	0	0	0

Major/Minor	Major1			Major2			Minor1			Minor2		
Conflicting Flow All	471	0	0	493	0	0	942	965	464	937	989	466
Stage 1	-	-	-	-	-	-	478	478	-	482	482	-
Stage 2	-	-	-	-	-	-	464	487	-	455	507	-
Critical Hdwy	4.12	-	-	4.12	-	-	7.12	6.52	6.22	7.12	6.52	6.22
Critical Hdwy Stg 1	-	-	-	-	-	-	6.12	5.52	-	6.12	5.52	-
Critical Hdwy Stg 2	-	-	-	-	-	-	6.12	5.52	-	6.12	5.52	-
Follow-up Hdwy	2.218	-	-	2.218	-	-	3.518	4.018	3.318	3.518	4.018	3.318
Pot Cap-1 Maneuver	1091	-	-	1071	-	-	243	255	598	245	247	597
Stage 1	-	-	-	-	-	-	568	556	-	565	553	-
Stage 2	-	-	-	-	-	-	578	550	-	585	539	-
Platoon blocked, %		-	-		-	-						
Mov Cap-1 Maneuver	1069	-	-	1037	-	-	232	238	579	228	230	585
Mov Cap-2 Maneuver	-	-	-	-	-	-	232	238	-	228	230	-
Stage 1	-	-	-	-	-	-	545	534	-	549	536	-
Stage 2	-	-	-	-	-	-	572	534	-	559	517	-

Approach	EB			WB			NB			SB		
HCM Control Delay, s	0.1			0.1			16.7			0		
HCM LOS							C			A		

Minor Lane/Major Mvmt	NBLn1	EBL	EBT	EBR	WBL	WBT	WBR	SBLn1
Capacity (veh/h)	345	1069	-	-	1037	-	-	-
HCM Lane V/C Ratio	0.11	0.006	-	-	0.008	-	-	-
HCM Control Delay (s)	16.7	8.4	0	-	8.5	0	-	0
HCM Lane LOS	C	A	A	-	A	A	-	A
HCM 95th %tile Q(veh)	0.4	0	-	-	0	-	-	-

Intersection												
Int Delay, s/veh	0.3											
Movement	EBL	EBT	EBR	WBL	WBT	WBR	NBL	NBT	NBR	SBL	SBT	SBR
Lane Configurations		↔			↔			↔			↔	
Traffic Vol, veh/h	0	397	6	2	400	0	1	0	2	7	0	7
Future Vol, veh/h	0	397	6	2	400	0	1	0	2	7	0	7
Conflicting Peds, #/hr	0	0	29	29	0	0	0	0	0	0	0	0
Sign Control	Free	Free	Free	Free	Free	Free	Stop	Stop	Stop	Stop	Stop	Stop
RT Channelized	-	-	None	-	-	None	-	-	None	-	-	None
Storage Length	-	-	-	-	-	-	-	-	-	-	-	-
Veh in Median Storage, #	-	0	-	-	0	-	-	0	-	-	0	-
Grade, %	-	0	-	-	0	-	-	0	-	-	0	-
Peak Hour Factor	86	86	86	86	86	86	86	86	86	86	86	86
Heavy Vehicles, %	2	2	2	2	2	2	2	2	2	2	2	2
Mvmt Flow	0	462	7	2	465	0	1	0	2	8	0	8

Major/Minor	Major1			Major2			Minor1			Minor2		
Conflicting Flow All	-	0	0	498	0	0	968	964	495	936	967	465
Stage 1	-	-	-	-	-	-	495	495	-	469	469	-
Stage 2	-	-	-	-	-	-	473	469	-	467	498	-
Critical Hdwy	-	-	-	4.12	-	-	7.12	6.52	6.22	7.12	6.52	6.22
Critical Hdwy Stg 1	-	-	-	-	-	-	6.12	5.52	-	6.12	5.52	-
Critical Hdwy Stg 2	-	-	-	-	-	-	6.12	5.52	-	6.12	5.52	-
Follow-up Hdwy	-	-	-	2.218	-	-	3.518	4.018	3.318	3.518	4.018	3.318
Pot Cap-1 Maneuver	0	-	-	1066	-	0	233	255	575	245	254	597
Stage 1	0	-	-	-	-	0	556	546	-	575	561	-
Stage 2	0	-	-	-	-	0	572	561	-	576	544	-
Platoon blocked, %	-	-	-	-	-	-	-	-	-	-	-	-
Mov Cap-1 Maneuver	-	-	-	1037	-	-	223	247	559	244	246	597
Mov Cap-2 Maneuver	-	-	-	-	-	-	223	247	-	244	246	-
Stage 1	-	-	-	-	-	-	556	531	-	575	559	-
Stage 2	-	-	-	-	-	-	563	559	-	574	529	-

Approach	EB	WB	NB	SB
HCM Control Delay, s	0	0	14.8	15.9
HCM LOS			B	C

Minor Lane/Major Mvmt	NBLn1	EBT	EBR	WBL	WBT	SBLn1
Capacity (veh/h)	372	-	-	1037	-	346
HCM Lane V/C Ratio	0.009	-	-	0.002	-	0.047
HCM Control Delay (s)	14.8	-	-	8.5	0	15.9
HCM Lane LOS	B	-	-	A	A	C
HCM 95th %tile Q(veh)	0	-	-	0	-	0.1

HCM 6th Signalized Intersection Summary
5: S B St & 9th Ave

Opening Year AM
06/09/2023



Movement	EBL	EBT	EBR	WBL	WBT	WBR	NBL	NBT	NBR	SBL	SBT	SBR
Lane Configurations		↕		↕	↕		↕	↕		↕	↕	
Traffic Volume (veh/h)	22	212	5	81	266	61	11	61	144	47	45	16
Future Volume (veh/h)	22	212	5	81	266	61	11	61	144	47	45	16
Initial Q (Qb), veh	0	0	0	0	0	0	0	0	0	0	0	0
Ped-Bike Adj(A_pbT)	0.99		0.98	0.99		0.95	0.99		0.96	0.99		0.96
Parking Bus, Adj	1.00	1.00	1.00	1.00	1.00	1.00	1.00	1.00	1.00	1.00	1.00	1.00
Work Zone On Approach		No			No			No			No	
Adj Sat Flow, veh/h/ln	1870	1870	1870	1870	1870	1870	1870	1870	1870	1870	1870	1870
Adj Flow Rate, veh/h	25	244	5	93	306	57	13	70	77	54	52	8
Peak Hour Factor	0.87	0.87	0.87	0.87	0.87	0.87	0.87	0.87	0.87	0.87	0.87	0.87
Percent Heavy Veh, %	2	2	2	2	2	2	2	2	2	2	2	2
Cap, veh/h	92	682	13	555	613	114	705	371	409	620	733	113
Arrive On Green	0.40	0.40	0.40	0.40	0.40	0.40	0.47	0.47	0.47	0.47	0.47	0.47
Sat Flow, veh/h	76	1690	33	1115	1519	283	1325	797	877	1227	1574	242
Grp Volume(v), veh/h	274	0	0	93	0	363	13	0	147	54	0	60
Grp Sat Flow(s),veh/h/ln	1799	0	0	1115	0	1802	1325	0	1674	1227	0	1816
Q Serve(g_s), s	0.0	0.0	0.0	0.0	0.0	9.7	0.4	0.0	3.3	1.7	0.0	1.2
Cycle Q Clear(g_c), s	6.6	0.0	0.0	3.8	0.0	9.7	1.5	0.0	3.3	5.0	0.0	1.2
Prop In Lane	0.09		0.02	1.00		0.16	1.00		0.52	1.00		0.13
Lane Grp Cap(c), veh/h	787	0	0	555	0	727	705	0	780	620	0	846
V/C Ratio(X)	0.35	0.00	0.00	0.17	0.00	0.50	0.02	0.00	0.19	0.09	0.00	0.07
Avail Cap(c_a), veh/h	787	0	0	555	0	727	705	0	780	620	0	846
HCM Platoon Ratio	1.00	1.00	1.00	1.00	1.00	1.00	1.00	1.00	1.00	1.00	1.00	1.00
Upstream Filter(I)	1.00	0.00	0.00	1.00	0.00	1.00	1.00	0.00	1.00	1.00	0.00	1.00
Uniform Delay (d), s/veh	13.4	0.0	0.0	12.6	0.0	14.3	9.9	0.0	10.1	11.5	0.0	9.5
Incr Delay (d2), s/veh	1.2	0.0	0.0	0.7	0.0	2.4	0.0	0.0	0.5	0.3	0.0	0.2
Initial Q Delay(d3),s/veh	0.0	0.0	0.0	0.0	0.0	0.0	0.0	0.0	0.0	0.0	0.0	0.0
%ile BackOfQ(50%),veh/ln	2.8	0.0	0.0	0.9	0.0	4.0	0.1	0.0	1.2	0.5	0.0	0.5
Unsig. Movement Delay, s/veh												
LnGrp Delay(d),s/veh	14.6	0.0	0.0	13.2	0.0	16.8	10.0	0.0	10.6	11.8	0.0	9.7
LnGrp LOS	B	A	A	B	A	B	A	A	B	B	A	A
Approach Vol, veh/h		274			456			160				114
Approach Delay, s/veh		14.6			16.0			10.6				10.7
Approach LOS		B			B			B				B
Timer - Assigned Phs		2		4		6		8				
Phs Duration (G+Y+Rc), s		30.2		34.2		30.2		34.2				
Change Period (Y+Rc), s		* 4.2		* 4.2		* 4.2		* 4.2				
Max Green Setting (Gmax), s		* 26		* 30		* 26		* 30				
Max Q Clear Time (g_c+I1), s		8.6		5.3		11.7		7.0				
Green Ext Time (p_c), s		0.3		1.2		0.4		0.6				

Intersection Summary

HCM 6th Ctrl Delay	14.2
HCM 6th LOS	B

Notes

* HCM 6th computational engine requires equal clearance times for the phases crossing the barrier.

Intersection	
Intersection Delay, s/veh	17.2
Intersection LOS	C

Movement	EBL	EBT	EBR	WBL	WBT	WBR	NBL	NBT	NBR	SBL	SBT	SBR
Lane Configurations		↕			↕			↕			↕	
Traffic Vol, veh/h	64	377	22	27	262	17	11	55	21	3	65	35
Future Vol, veh/h	64	377	22	27	262	17	11	55	21	3	65	35
Peak Hour Factor	0.88	0.88	0.88	0.88	0.88	0.88	0.88	0.88	0.88	0.88	0.88	0.88
Heavy Vehicles, %	2	2	2	2	2	2	2	2	2	2	2	2
Mvmt Flow	73	428	25	31	298	19	13	63	24	3	74	40
Number of Lanes	0	1	0	0	1	0	0	1	0	0	1	0

Approach	EB	WB	NB	SB
Opposing Approach	WB	EB	SB	NB
Opposing Lanes	1	1	1	1
Conflicting Approach Left	SB	NB	EB	WB
Conflicting Lanes Left	1	1	1	1
Conflicting Approach Right	NB	SB	WB	EB
Conflicting Lanes Right	1	1	1	1
HCM Control Delay	22	14	10.7	10.8
HCM LOS	C	B	B	B

Lane	NBLn1	EBLn1	WBLn1	SBLn1
Vol Left, %	13%	14%	9%	3%
Vol Thru, %	63%	81%	86%	63%
Vol Right, %	24%	5%	6%	34%
Sign Control	Stop	Stop	Stop	Stop
Traffic Vol by Lane	87	463	306	103
LT Vol	11	64	27	3
Through Vol	55	377	262	65
RT Vol	21	22	17	35
Lane Flow Rate	99	526	348	117
Geometry Grp	1	1	1	1
Degree of Util (X)	0.173	0.75	0.517	0.201
Departure Headway (Hd)	6.308	5.131	5.349	6.181
Convergence, Y/N	Yes	Yes	Yes	Yes
Cap	566	705	671	577
Service Time	4.381	3.175	3.4	4.252
HCM Lane V/C Ratio	0.175	0.746	0.519	0.203
HCM Control Delay	10.7	22	14	10.8
HCM Lane LOS	B	C	B	B
HCM 95th-tile Q	0.6	6.8	3	0.7

Intersection	
Intersection Delay, s/veh	12
Intersection LOS	B

Movement	EBL	EBT	EBR	WBL	WBT	WBR	NBL	NBT	NBR	SBL	SBT	SBR
Lane Configurations		↕			↕			↕			↕	
Traffic Vol, veh/h	35	290	66	20	219	12	41	40	27	22	47	45
Future Vol, veh/h	35	290	66	20	219	12	41	40	27	22	47	45
Peak Hour Factor	0.97	0.97	0.97	0.97	0.97	0.97	0.97	0.97	0.97	0.97	0.97	0.97
Heavy Vehicles, %	2	2	2	2	2	2	2	2	2	2	2	2
Mvmt Flow	36	299	68	21	226	12	42	41	28	23	48	46
Number of Lanes	0	1	0	0	1	0	0	1	0	0	1	0

Approach	EB	WB	NB	SB
Opposing Approach	WB	EB	SB	NB
Opposing Lanes	1	1	1	1
Conflicting Approach Left	SB	NB	EB	WB
Conflicting Lanes Left	1	1	1	1
Conflicting Approach Right	NB	SB	WB	EB
Conflicting Lanes Right	1	1	1	1
HCM Control Delay	13.7	11.2	10	9.9
HCM LOS	B	B	A	A

Lane	NBLn1	EBLn1	WBLn1	SBLn1
Vol Left, %	38%	9%	8%	19%
Vol Thru, %	37%	74%	87%	41%
Vol Right, %	25%	17%	5%	39%
Sign Control	Stop	Stop	Stop	Stop
Traffic Vol by Lane	108	391	251	114
LT Vol	41	35	20	22
Through Vol	40	290	219	47
RT Vol	27	66	12	45
Lane Flow Rate	111	403	259	118
Geometry Grp	1	1	1	1
Degree of Util (X)	0.177	0.55	0.369	0.183
Departure Headway (Hd)	5.735	4.91	5.132	5.601
Convergence, Y/N	Yes	Yes	Yes	Yes
Cap	625	738	701	639
Service Time	3.782	2.91	3.166	3.647
HCM Lane V/C Ratio	0.178	0.546	0.369	0.185
HCM Control Delay	10	13.7	11.2	9.9
HCM Lane LOS	A	B	B	A
HCM 95th-tile Q	0.6	3.4	1.7	0.7

Intersection												
Int Delay, s/veh	0.7											
Movement	EBL	EBT	EBR	WBL	WBT	WBR	NBL	NBT	NBR	SBL	SBT	SBR
Lane Configurations		↕			↕	↕		↕			↕	
Traffic Vol, veh/h	1	373	42	4	300	1	17	0	18	0	0	0
Future Vol, veh/h	1	373	42	4	300	1	17	0	18	0	0	0
Conflicting Peds, #/hr	28	0	32	32	0	28	0	0	0	0	0	0
Sign Control	Free	Free	Free	Free	Free	Free	Stop	Stop	Stop	Stop	Stop	Stop
RT Channelized	-	-	None	-	-	None	-	-	None	-	-	None
Storage Length	-	-	-	-	-	75	-	-	-	-	-	-
Veh in Median Storage, #	-	0	-	-	0	-	-	0	-	-	0	-
Grade, %	-	0	-	-	0	-	-	0	-	-	0	-
Peak Hour Factor	94	94	94	94	94	94	94	94	94	94	94	94
Heavy Vehicles, %	2	2	2	2	2	2	2	2	2	2	2	2
Mvmt Flow	1	397	45	4	319	1	18	0	19	0	0	0

Major/Minor	Major1			Major2			Minor1			Minor2		
Conflicting Flow All	348	0	0	474	0	0	782	810	452	786	831	347
Stage 1	-	-	-	-	-	-	454	454	-	355	355	-
Stage 2	-	-	-	-	-	-	328	356	-	431	476	-
Critical Hdwy	4.12	-	-	4.12	-	-	7.12	6.52	6.22	7.12	6.52	6.22
Critical Hdwy Stg 1	-	-	-	-	-	-	6.12	5.52	-	6.12	5.52	-
Critical Hdwy Stg 2	-	-	-	-	-	-	6.12	5.52	-	6.12	5.52	-
Follow-up Hdwy	2.218	-	-	2.218	-	-	3.518	4.018	3.318	3.518	4.018	3.318
Pot Cap-1 Maneuver	1211	-	-	1088	-	-	312	314	608	310	305	696
Stage 1	-	-	-	-	-	-	586	569	-	662	630	-
Stage 2	-	-	-	-	-	-	685	629	-	603	557	-
Platoon blocked, %		-	-		-	-						
Mov Cap-1 Maneuver	1179	-	-	1055	-	-	301	295	589	290	286	677
Mov Cap-2 Maneuver	-	-	-	-	-	-	301	295	-	290	286	-
Stage 1	-	-	-	-	-	-	568	551	-	643	610	-
Stage 2	-	-	-	-	-	-	682	609	-	583	540	-

Approach	EB			WB			NB			SB		
HCM Control Delay, s	0			0.1			14.9			0		
HCM LOS							B			A		

Minor Lane/Major Mvmt	NBLn1	EBL	EBT	EBR	WBL	WBT	WBR	SBLn1
Capacity (veh/h)	402	1179	-	-	1055	-	-	-
HCM Lane V/C Ratio	0.093	0.001	-	-	0.004	-	-	-
HCM Control Delay (s)	14.9	8.1	0	-	8.4	0	-	0
HCM Lane LOS	B	A	A	-	A	A	-	A
HCM 95th %tile Q(veh)	0.3	0	-	-	0	-	-	-

Intersection												
Int Delay, s/veh	0.7											
Movement	EBL	EBT	EBR	WBL	WBT	WBR	NBL	NBT	NBR	SBL	SBT	SBR
Lane Configurations		↗			↖			↔			↔	
Traffic Vol, veh/h	0	396	0	0	317	0	0	0	0	20	0	18
Future Vol, veh/h	0	396	0	0	317	0	0	0	0	20	0	18
Conflicting Peds, #/hr	0	0	27	27	0	0	0	0	0	0	0	0
Sign Control	Free	Free	Free	Free	Free	Free	Stop	Stop	Stop	Stop	Stop	Stop
RT Channelized	-	-	None	-	-	None	-	-	None	-	-	None
Storage Length	-	-	-	-	-	-	-	-	-	-	-	-
Veh in Median Storage, #	-	0	-	-	0	-	-	0	-	-	0	-
Grade, %	-	0	-	-	0	-	-	0	-	-	0	-
Peak Hour Factor	93	93	93	93	93	93	93	93	93	93	93	93
Heavy Vehicles, %	2	2	2	2	2	2	2	2	2	2	2	2
Mvmt Flow	0	426	0	0	341	0	0	0	0	22	0	19

Major/Minor	Major1			Major2			Minor1			Minor2		
Conflicting Flow All	-	0	0	453	0	0	804	794	453	767	794	341
Stage 1	-	-	-	-	-	-	453	453	-	341	341	-
Stage 2	-	-	-	-	-	-	351	341	-	426	453	-
Critical Hdwy	-	-	-	4.12	-	-	7.12	6.52	6.22	7.12	6.52	6.22
Critical Hdwy Stg 1	-	-	-	-	-	-	6.12	5.52	-	6.12	5.52	-
Critical Hdwy Stg 2	-	-	-	-	-	-	6.12	5.52	-	6.12	5.52	-
Follow-up Hdwy	-	-	-	2.218	-	-	3.518	4.018	3.318	3.518	4.018	3.318
Pot Cap-1 Maneuver	0	-	-	1108	-	0	301	321	607	319	321	701
Stage 1	0	-	-	-	-	0	586	570	-	674	639	-
Stage 2	0	-	-	-	-	0	666	639	-	606	570	-
Platoon blocked, %	-	-	-	-	-	-	-	-	-	-	-	-
Mov Cap-1 Maneuver	-	-	-	1080	-	-	285	313	591	319	313	701
Mov Cap-2 Maneuver	-	-	-	-	-	-	285	313	-	319	313	-
Stage 1	-	-	-	-	-	-	586	555	-	674	639	-
Stage 2	-	-	-	-	-	-	648	639	-	606	555	-

Approach	EB	WB	NB	SB
HCM Control Delay, s	0	0	0	14.2
HCM LOS			A	B

Minor Lane/Major Mvmt	NBLn1	EBT	EBR	WBL	WBT	SBLn1
Capacity (veh/h)	-	-	-	1080	-	430
HCM Lane V/C Ratio	-	-	-	-	-	0.095
HCM Control Delay (s)	0	-	-	0	-	14.2
HCM Lane LOS	A	-	-	A	-	B
HCM 95th %tile Q(veh)	-	-	-	0	-	0.3

HCM 6th Signalized Intersection Summary
5: S B St & 9th Ave

Opening Year PM
06/09/2023



Movement	EBL	EBT	EBR	WBL	WBT	WBR	NBL	NBT	NBR	SBL	SBT	SBR
Lane Configurations		↔		↔	↔		↔	↔		↔	↔	
Traffic Volume (veh/h)	26	201	11	85	183	67	6	75	126	69	49	33
Future Volume (veh/h)	26	201	11	85	183	67	6	75	126	69	49	33
Initial Q (Qb), veh	0	0	0	0	0	0	0	0	0	0	0	0
Ped-Bike Adj(A_pbT)	0.97		0.93	0.97		0.93	0.98		0.95	0.98		0.95
Parking Bus, Adj	1.00	1.00	1.00	1.00	1.00	1.00	1.00	1.00	1.00	1.00	1.00	1.00
Work Zone On Approach		No			No			No			No	
Adj Sat Flow, veh/h/ln	1870	1870	1870	1870	1870	1870	1870	1870	1870	1870	1870	1870
Adj Flow Rate, veh/h	28	216	9	91	197	50	6	81	63	74	53	16
Peak Hour Factor	0.93	0.93	0.93	0.93	0.93	0.93	0.93	0.93	0.93	0.93	0.93	0.93
Percent Heavy Veh, %	2	2	2	2	2	2	2	2	2	2	2	2
Cap, veh/h	102	655	26	563	571	145	690	444	345	619	634	192
Arrive On Green	0.40	0.40	0.40	0.40	0.40	0.40	0.47	0.47	0.47	0.47	0.47	0.47
Sat Flow, veh/h	98	1622	63	1119	1414	359	1301	952	741	1220	1362	411
Grp Volume(v), veh/h	253	0	0	91	0	247	6	0	144	74	0	69
Grp Sat Flow(s),veh/h/ln	1784	0	0	1119	0	1772	1301	0	1693	1220	0	1773
Q Serve(g_s), s	0.0	0.0	0.0	0.0	0.0	6.2	0.2	0.0	3.2	2.4	0.0	1.4
Cycle Q Clear(g_c), s	6.1	0.0	0.0	3.4	0.0	6.2	1.6	0.0	3.2	5.6	0.0	1.4
Prop In Lane	0.11		0.04	1.00		0.20	1.00		0.44	1.00		0.23
Lane Grp Cap(c), veh/h	782	0	0	563	0	716	690	0	789	619	0	826
V/C Ratio(X)	0.32	0.00	0.00	0.16	0.00	0.35	0.01	0.00	0.18	0.12	0.00	0.08
Avail Cap(c_a), veh/h	782	0	0	563	0	716	690	0	789	619	0	826
HCM Platoon Ratio	1.00	1.00	1.00	1.00	1.00	1.00	1.00	1.00	1.00	1.00	1.00	1.00
Upstream Filter(I)	1.00	0.00	0.00	1.00	0.00	1.00	1.00	0.00	1.00	1.00	0.00	1.00
Uniform Delay (d), s/veh	13.3	0.0	0.0	12.5	0.0	13.3	10.0	0.0	10.0	11.7	0.0	9.6
Incr Delay (d2), s/veh	1.1	0.0	0.0	0.6	0.0	1.3	0.0	0.0	0.5	0.4	0.0	0.2
Initial Q Delay(d3),s/veh	0.0	0.0	0.0	0.0	0.0	0.0	0.0	0.0	0.0	0.0	0.0	0.0
%ile BackOfQ(50%),veh/ln	2.5	0.0	0.0	0.9	0.0	2.5	0.0	0.0	1.2	0.7	0.0	0.5
Unsig. Movement Delay, s/veh												
LnGrp Delay(d),s/veh	14.4	0.0	0.0	13.1	0.0	14.6	10.0	0.0	10.6	12.1	0.0	9.8
LnGrp LOS	B	A	A	B	A	B	B	A	B	B	A	A
Approach Vol, veh/h		253			338			150				143
Approach Delay, s/veh		14.4			14.2			10.5				11.0
Approach LOS		B			B			B				B
Timer - Assigned Phs		2		4		6		8				
Phs Duration (G+Y+Rc), s		30.2		34.2		30.2		34.2				
Change Period (Y+Rc), s		* 4.2		* 4.2		* 4.2		* 4.2				
Max Green Setting (Gmax), s		* 26		* 30		* 26		* 30				
Max Q Clear Time (g_c+I1), s		8.1		5.2		8.2		7.6				
Green Ext Time (p_c), s		0.3		1.2		0.3		0.8				

Intersection Summary

HCM 6th Ctrl Delay	13.1
HCM 6th LOS	B

Notes

* HCM 6th computational engine requires equal clearance times for the phases crossing the barrier.

Intersection	
Intersection Delay, s/veh	11.6
Intersection LOS	B

Movement	EBL	EBT	EBR	WBL	WBT	WBR	NBL	NBT	NBR	SBL	SBT	SBR
Lane Configurations		↕			↕			↕			↕	
Traffic Vol, veh/h	47	208	18	66	291	20	8	86	24	0	42	39
Future Vol, veh/h	47	208	18	66	291	20	8	86	24	0	42	39
Peak Hour Factor	0.99	0.99	0.99	0.99	0.99	0.99	0.99	0.99	0.99	0.99	0.99	0.99
Heavy Vehicles, %	2	2	2	2	2	2	2	2	2	2	2	2
Mvmt Flow	47	210	18	67	294	20	8	87	24	0	42	39
Number of Lanes	0	1	0	0	1	0	0	1	0	0	1	0

Approach	EB	WB	NB	SB
Opposing Approach	WB	EB	SB	NB
Opposing Lanes	1	1	1	1
Conflicting Approach Left	SB	NB	EB	WB
Conflicting Lanes Left	1	1	1	1
Conflicting Approach Right	NB	SB	WB	EB
Conflicting Lanes Right	1	1	1	1
HCM Control Delay	11.1	12.9	9.9	9.3
HCM LOS	B	B	A	A

Lane	NBLn1	EBLn1	WBLn1	SBLn1
Vol Left, %	7%	17%	18%	0%
Vol Thru, %	73%	76%	77%	52%
Vol Right, %	20%	7%	5%	48%
Sign Control	Stop	Stop	Stop	Stop
Traffic Vol by Lane	118	273	377	81
LT Vol	8	47	66	0
Through Vol	86	208	291	42
RT Vol	24	18	20	39
Lane Flow Rate	119	276	381	82
Geometry Grp	1	1	1	1
Degree of Util (X)	0.185	0.385	0.508	0.125
Departure Headway (Hd)	5.598	5.024	4.91	5.497
Convergence, Y/N	Yes	Yes	Yes	Yes
Cap	642	720	739	654
Service Time	3.616	3.024	2.91	3.517
HCM Lane V/C Ratio	0.185	0.383	0.516	0.125
HCM Control Delay	9.9	11.1	12.9	9.3
HCM Lane LOS	A	B	B	A
HCM 95th-tile Q	0.7	1.8	2.9	0.4

Intersection												
Intersection Delay, s/veh	14.5											
Intersection LOS	B											

Movement	EBL	EBT	EBR	WBL	WBT	WBR	NBL	NBT	NBR	SBL	SBT	SBR
Lane Configurations		↕			↕			↕			↕	
Traffic Vol, veh/h	36	256	78	25	280	10	80	62	14	16	70	39
Future Vol, veh/h	36	256	78	25	280	10	80	62	14	16	70	39
Peak Hour Factor	0.91	0.91	0.91	0.91	0.91	0.91	0.91	0.91	0.91	0.91	0.91	0.91
Heavy Vehicles, %	2	2	2	2	2	2	2	2	2	2	2	2
Mvmt Flow	40	281	86	27	308	11	88	68	15	18	77	43
Number of Lanes	0	1	0	0	1	0	0	1	0	0	1	0

Approach	EB	WB	NB	SB
Opposing Approach	WB	EB	SB	NB
Opposing Lanes	1	1	1	1
Conflicting Approach Left	SB	NB	EB	WB
Conflicting Lanes Left	1	1	1	1
Conflicting Approach Right	NB	SB	WB	EB
Conflicting Lanes Right	1	1	1	1
HCM Control Delay	16.4	14.9	12.1	11.2
HCM LOS	C	B	B	B

Lane	NBLn1	EBLn1	WBLn1	SBLn1
Vol Left, %	51%	10%	8%	13%
Vol Thru, %	40%	69%	89%	56%
Vol Right, %	9%	21%	3%	31%
Sign Control	Stop	Stop	Stop	Stop
Traffic Vol by Lane	156	370	315	125
LT Vol	80	36	25	16
Through Vol	62	256	280	70
RT Vol	14	78	10	39
Lane Flow Rate	171	407	346	137
Geometry Grp	1	1	1	1
Degree of Util (X)	0.3	0.606	0.534	0.236
Departure Headway (Hd)	6.294	5.365	5.549	6.179
Convergence, Y/N	Yes	Yes	Yes	Yes
Cap	566	667	647	576
Service Time	4.383	3.433	3.621	4.273
HCM Lane V/C Ratio	0.302	0.61	0.535	0.238
HCM Control Delay	12.1	16.4	14.9	11.2
HCM Lane LOS	B	C	B	B
HCM 95th-tile Q	1.3	4.1	3.2	0.9

Intersection												
Int Delay, s/veh	1.1											
Movement	EBL	EBT	EBR	WBL	WBT	WBR	NBL	NBT	NBR	SBL	SBT	SBR
Lane Configurations		↕			↕	↕		↕			↕	
Traffic Vol, veh/h	14	347	48	7	383	9	15	0	18	5	0	11
Future Vol, veh/h	14	347	48	7	383	9	15	0	18	5	0	11
Conflicting Peds, #/hr	21	0	33	0	0	21	0	0	0	0	0	0
Sign Control	Free	Free	Free	Free	Free	Free	Stop	Stop	Stop	Stop	Stop	Stop
RT Channelized	-	-	None	-	-	None	-	-	None	-	-	None
Storage Length	-	-	-	-	-	75	-	-	-	-	-	-
Veh in Median Storage, #	-	0	-	-	0	-	-	0	-	-	0	-
Grade, %	-	0	-	-	0	-	-	0	-	-	0	-
Peak Hour Factor	87	87	87	87	87	87	87	87	87	87	87	87
Heavy Vehicles, %	2	2	2	2	2	2	2	2	2	2	2	2
Mvmt Flow	16	399	55	8	440	10	17	0	21	6	0	13

Major/Minor	Major1			Major2			Minor1			Minor2		
Conflicting Flow All	471	0	0	487	0	0	960	979	460	946	996	461
Stage 1	-	-	-	-	-	-	492	492	-	477	477	-
Stage 2	-	-	-	-	-	-	468	487	-	469	519	-
Critical Hdwy	4.12	-	-	4.12	-	-	7.12	6.52	6.22	7.12	6.52	6.22
Critical Hdwy Stg 1	-	-	-	-	-	-	6.12	5.52	-	6.12	5.52	-
Critical Hdwy Stg 2	-	-	-	-	-	-	6.12	5.52	-	6.12	5.52	-
Follow-up Hdwy	2.218	-	-	2.218	-	-	3.518	4.018	3.318	3.518	4.018	3.318
Pot Cap-1 Maneuver	1091	-	-	1076	-	-	236	250	601	241	244	600
Stage 1	-	-	-	-	-	-	558	548	-	569	556	-
Stage 2	-	-	-	-	-	-	575	550	-	575	533	-
Platoon blocked, %		-	-		-	-						
Mov Cap-1 Maneuver	1069	-	-	1042	-	-	219	230	582	223	225	588
Mov Cap-2 Maneuver	-	-	-	-	-	-	219	230	-	223	225	-
Stage 1	-	-	-	-	-	-	530	521	-	546	539	-
Stage 2	-	-	-	-	-	-	557	534	-	543	506	-

Approach	EB			WB			NB			SB		
HCM Control Delay, s	0.3			0.1			17.2			14.7		
HCM LOS							C			B		

Minor Lane/Major Mvmt	NBLn1	EBL	EBT	EBR	WBL	WBT	WBR	SBLn1
Capacity (veh/h)	332	1069	-	-	1042	-	-	389
HCM Lane V/C Ratio	0.114	0.015	-	-	0.008	-	-	0.047
HCM Control Delay (s)	17.2	8.4	0	-	8.5	0	-	14.7
HCM Lane LOS	C	A	A	-	A	A	-	B
HCM 95th %tile Q(veh)	0.4	0	-	-	0	-	-	0.1

Intersection												
Int Delay, s/veh	0.3											
Movement	EBL	EBT	EBR	WBL	WBT	WBR	NBL	NBT	NBR	SBL	SBT	SBR
Lane Configurations		↔			↔			↔			↔	
Traffic Vol, veh/h	0	400	6	2	407	0	1	0	2	7	0	7
Future Vol, veh/h	0	400	6	2	407	0	1	0	2	7	0	7
Conflicting Peds, #/hr	0	0	29	29	0	0	0	0	0	0	0	0
Sign Control	Free	Free	Free	Free	Free	Free	Stop	Stop	Stop	Stop	Stop	Stop
RT Channelized	-	-	None	-	-	None	-	-	None	-	-	None
Storage Length	-	-	-	-	-	-	-	-	-	-	-	-
Veh in Median Storage, #	-	0	-	-	0	-	-	0	-	-	0	-
Grade, %	-	0	-	-	0	-	-	0	-	-	0	-
Peak Hour Factor	86	86	86	86	86	86	86	86	86	86	86	86
Heavy Vehicles, %	2	2	2	2	2	2	2	2	2	2	2	2
Mvmt Flow	0	465	7	2	473	0	1	0	2	8	0	8

Major/Minor	Major1			Major2			Minor1			Minor2		
Conflicting Flow All	-	0	0	501	0	0	979	975	498	947	978	473
Stage 1	-	-	-	-	-	-	498	498	-	477	477	-
Stage 2	-	-	-	-	-	-	481	477	-	470	501	-
Critical Hdwy	-	-	-	4.12	-	-	7.12	6.52	6.22	7.12	6.52	6.22
Critical Hdwy Stg 1	-	-	-	-	-	-	6.12	5.52	-	6.12	5.52	-
Critical Hdwy Stg 2	-	-	-	-	-	-	6.12	5.52	-	6.12	5.52	-
Follow-up Hdwy	-	-	-	2.218	-	-	3.518	4.018	3.318	3.518	4.018	3.318
Pot Cap-1 Maneuver	0	-	-	1063	-	0	229	251	572	241	250	591
Stage 1	0	-	-	-	-	0	554	544	-	569	556	-
Stage 2	0	-	-	-	-	0	566	556	-	574	543	-
Platoon blocked, %	-	-	-	-	-	-	-	-	-	-	-	-
Mov Cap-1 Maneuver	-	-	-	1034	-	-	219	243	556	240	242	591
Mov Cap-2 Maneuver	-	-	-	-	-	-	219	243	-	240	242	-
Stage 1	-	-	-	-	-	-	554	529	-	569	554	-
Stage 2	-	-	-	-	-	-	557	554	-	572	528	-

Approach	EB	WB	NB	SB
HCM Control Delay, s	0	0	14.9	16.1
HCM LOS			B	C

Minor Lane/Major Mvmt	NBLn1	EBT	EBR	WBL	WBT	SBLn1
Capacity (veh/h)	367	-	-	1034	-	341
HCM Lane V/C Ratio	0.01	-	-	0.002	-	0.048
HCM Control Delay (s)	14.9	-	-	8.5	0	16.1
HCM Lane LOS	B	-	-	A	A	C
HCM 95th %tile Q(veh)	0	-	-	0	-	0.1

HCM 6th Signalized Intersection Summary
5: S B St & 9th Ave

Opening Year Plus Project AM
06/09/2023



Movement	EBL	EBT	EBR	WBL	WBT	WBR	NBL	NBT	NBR	SBL	SBT	SBR
Lane Configurations		↔		↔	↔		↔	↔		↔	↔	
Traffic Volume (veh/h)	22	213	5	83	268	64	11	61	144	49	45	16
Future Volume (veh/h)	22	213	5	83	268	64	11	61	144	49	45	16
Initial Q (Qb), veh	0	0	0	0	0	0	0	0	0	0	0	0
Ped-Bike Adj(A_pbT)	0.99		0.98	0.99		0.95	0.99		0.96	0.99		0.96
Parking Bus, Adj	1.00	1.00	1.00	1.00	1.00	1.00	1.00	1.00	1.00	1.00	1.00	1.00
Work Zone On Approach		No			No			No			No	
Adj Sat Flow, veh/h/ln	1870	1870	1870	1870	1870	1870	1870	1870	1870	1870	1870	1870
Adj Flow Rate, veh/h	25	245	5	95	308	61	13	70	77	56	52	8
Peak Hour Factor	0.87	0.87	0.87	0.87	0.87	0.87	0.87	0.87	0.87	0.87	0.87	0.87
Percent Heavy Veh, %	2	2	2	2	2	2	2	2	2	2	2	2
Cap, veh/h	92	682	13	554	606	120	705	371	409	620	733	113
Arrive On Green	0.40	0.40	0.40	0.40	0.40	0.40	0.47	0.47	0.47	0.47	0.47	0.47
Sat Flow, veh/h	76	1690	33	1115	1501	297	1325	797	877	1227	1574	242
Grp Volume(v), veh/h	275	0	0	95	0	369	13	0	147	56	0	60
Grp Sat Flow(s),veh/h/ln	1798	0	0	1115	0	1798	1325	0	1674	1227	0	1816
Q Serve(g_s), s	0.0	0.0	0.0	0.0	0.0	9.9	0.4	0.0	3.3	1.8	0.0	1.2
Cycle Q Clear(g_c), s	6.6	0.0	0.0	3.9	0.0	9.9	1.5	0.0	3.3	5.1	0.0	1.2
Prop In Lane	0.09		0.02	1.00		0.17	1.00		0.52	1.00		0.13
Lane Grp Cap(c), veh/h	787	0	0	554	0	726	705	0	780	620	0	846
V/C Ratio(X)	0.35	0.00	0.00	0.17	0.00	0.51	0.02	0.00	0.19	0.09	0.00	0.07
Avail Cap(c_a), veh/h	787	0	0	554	0	726	705	0	780	620	0	846
HCM Platoon Ratio	1.00	1.00	1.00	1.00	1.00	1.00	1.00	1.00	1.00	1.00	1.00	1.00
Upstream Filter(I)	1.00	0.00	0.00	1.00	0.00	1.00	1.00	0.00	1.00	1.00	0.00	1.00
Uniform Delay (d), s/veh	13.4	0.0	0.0	12.6	0.0	14.4	9.9	0.0	10.1	11.6	0.0	9.5
Incr Delay (d2), s/veh	1.2	0.0	0.0	0.7	0.0	2.5	0.0	0.0	0.5	0.3	0.0	0.2
Initial Q Delay(d3),s/veh	0.0	0.0	0.0	0.0	0.0	0.0	0.0	0.0	0.0	0.0	0.0	0.0
%ile BackOfQ(50%),veh/ln	2.8	0.0	0.0	0.9	0.0	4.1	0.1	0.0	1.2	0.5	0.0	0.5
Unsig. Movement Delay, s/veh												
LnGrp Delay(d),s/veh	14.7	0.0	0.0	13.3	0.0	16.9	10.0	0.0	10.6	11.9	0.0	9.7
LnGrp LOS	B	A	A	B	A	B	A	A	B	B	A	A
Approach Vol, veh/h		275			464			160				116
Approach Delay, s/veh		14.7			16.2			10.6				10.7
Approach LOS		B			B			B				B
Timer - Assigned Phs		2		4		6		8				
Phs Duration (G+Y+Rc), s		30.2		34.2		30.2		34.2				
Change Period (Y+Rc), s		* 4.2		* 4.2		* 4.2		* 4.2				
Max Green Setting (Gmax), s		* 26		* 30		* 26		* 30				
Max Q Clear Time (g_c+I1), s		8.6		5.3		11.9		7.1				
Green Ext Time (p_c), s		0.3		1.2		0.4		0.6				

Intersection Summary

HCM 6th Ctrl Delay	14.3
HCM 6th LOS	B

Notes

* HCM 6th computational engine requires equal clearance times for the phases crossing the barrier.

Intersection	
Intersection Delay, s/veh	17.8
Intersection LOS	C

Movement	EBL	EBT	EBR	WBL	WBT	WBR	NBL	NBT	NBR	SBL	SBT	SBR
Lane Configurations		↕			↕			↕			↕	
Traffic Vol, veh/h	64	377	21	30	262	17	13	57	23	3	75	35
Future Vol, veh/h	64	377	21	30	262	17	13	57	23	3	75	35
Peak Hour Factor	0.88	0.88	0.88	0.88	0.88	0.88	0.88	0.88	0.88	0.88	0.88	0.88
Heavy Vehicles, %	2	2	2	2	2	2	2	2	2	2	2	2
Mvmt Flow	73	428	24	34	298	19	15	65	26	3	85	40
Number of Lanes	0	1	0	0	1	0	0	1	0	0	1	0

Approach	EB	WB	NB	SB
Opposing Approach	WB	EB	SB	NB
Opposing Lanes	1	1	1	1
Conflicting Approach Left	SB	NB	EB	WB
Conflicting Lanes Left	1	1	1	1
Conflicting Approach Right	NB	SB	WB	EB
Conflicting Lanes Right	1	1	1	1
HCM Control Delay	23	14.5	10.9	11.1
HCM LOS	C	B	B	B

Lane	NBLn1	EBLn1	WBLn1	SBLn1
Vol Left, %	14%	14%	10%	3%
Vol Thru, %	61%	82%	85%	66%
Vol Right, %	25%	5%	6%	31%
Sign Control	Stop	Stop	Stop	Stop
Traffic Vol by Lane	93	462	309	113
LT Vol	13	64	30	3
Through Vol	57	377	262	75
RT Vol	23	21	17	35
Lane Flow Rate	106	525	351	128
Geometry Grp	1	1	1	1
Degree of Util (X)	0.187	0.761	0.53	0.223
Departure Headway (Hd)	6.377	5.217	5.437	6.254
Convergence, Y/N	Yes	Yes	Yes	Yes
Cap	559	693	660	570
Service Time	4.461	3.267	3.496	4.335
HCM Lane V/C Ratio	0.19	0.758	0.532	0.225
HCM Control Delay	10.9	23	14.5	11.1
HCM Lane LOS	B	C	B	B
HCM 95th-tile Q	0.7	7.1	3.1	0.8

Intersection

Intersection Delay, s/veh 12.1
Intersection LOS B

Movement	EBL	EBT	EBR	WBL	WBT	WBR	NBL	NBT	NBR	SBL	SBT	SBR
Lane Configurations		↕			↕			↕			↕	
Traffic Vol, veh/h	35	292	66	20	222	12	43	42	27	22	48	45
Future Vol, veh/h	35	292	66	20	222	12	43	42	27	22	48	45
Peak Hour Factor	0.97	0.97	0.97	0.97	0.97	0.97	0.97	0.97	0.97	0.97	0.97	0.97
Heavy Vehicles, %	2	2	2	2	2	2	2	2	2	2	2	2
Mvmt Flow	36	301	68	21	229	12	44	43	28	23	49	46
Number of Lanes	0	1	0	0	1	0	0	1	0	0	1	0

Approach	EB	WB	NB	SB
Opposing Approach	WB	EB	SB	NB
Opposing Lanes	1	1	1	1
Conflicting Approach Left SB		NB	EB	WB
Conflicting Lanes Left	1	1	1	1
Conflicting Approach Right NB		SB	WB	EB
Conflicting Lanes Right	1	1	1	1
HCM Control Delay	13.9	11.3	10.1	10
HCM LOS	B	B	B	A

Lane	NBLn1	EBLn1	WBLn1	SBLn1
Vol Left, %	38%	9%	8%	19%
Vol Thru, %	38%	74%	87%	42%
Vol Right, %	24%	17%	5%	39%
Sign Control	Stop	Stop	Stop	Stop
Traffic Vol by Lane	112	393	254	115
LT Vol	43	35	20	22
Through Vol	42	292	222	48
RT Vol	27	66	12	45
Lane Flow Rate	115	405	262	119
Geometry Grp	1	1	1	1
Degree of Util (X)	0.185	0.553	0.375	0.186
Departure Headway (Hd)	5.765	4.91	5.159	5.633
Convergence, Y/N	Yes	Yes	Yes	Yes
Cap	621	733	697	635
Service Time	3.808	2.939	3.193	3.676
HCM Lane V/C Ratio	0.185	0.553	0.376	0.187
HCM Control Delay	10.1	13.9	11.3	10
HCM Lane LOS	B	B	B	A
HCM 95th-tile Q	0.7	3.4	1.7	0.7

Intersection												
Int Delay, s/veh	1.2											
Movement	EBL	EBT	EBR	WBL	WBT	WBR	NBL	NBT	NBR	SBL	SBT	SBR
Lane Configurations		↕			↕	↕		↕			↕	
Traffic Vol, veh/h	13	370	44	4	300	6	17	0	18	5	0	16
Future Vol, veh/h	13	370	44	4	300	6	17	0	18	5	0	16
Conflicting Peds, #/hr	28	0	32	32	0	28	0	0	0	0	0	0
Sign Control	Free	Free	Free	Free	Free	Free	Stop	Stop	Stop	Stop	Stop	Stop
RT Channelized	-	-	None	-	-	None	-	-	None	-	-	None
Storage Length	-	-	-	-	-	75	-	-	-	-	-	-
Veh in Median Storage, #	-	0	-	-	0	-	-	0	-	-	0	-
Grade, %	-	0	-	-	0	-	-	0	-	-	0	-
Peak Hour Factor	94	94	94	94	94	94	94	94	94	94	94	94
Heavy Vehicles, %	2	2	2	2	2	2	2	2	2	2	2	2
Mvmt Flow	14	394	47	4	319	6	18	0	19	5	0	17

Major/Minor	Major1			Major2			Minor1			Minor2		
Conflicting Flow All	353	0	0	473	0	0	817	839	450	810	856	347
Stage 1	-	-	-	-	-	-	478	478	-	355	355	-
Stage 2	-	-	-	-	-	-	339	361	-	455	501	-
Critical Hdwy	4.12	-	-	4.12	-	-	7.12	6.52	6.22	7.12	6.52	6.22
Critical Hdwy Stg 1	-	-	-	-	-	-	6.12	5.52	-	6.12	5.52	-
Critical Hdwy Stg 2	-	-	-	-	-	-	6.12	5.52	-	6.12	5.52	-
Follow-up Hdwy	2.218	-	-	2.218	-	-	3.518	4.018	3.318	3.518	4.018	3.318
Pot Cap-1 Maneuver	1206	-	-	1089	-	-	295	302	609	298	295	696
Stage 1	-	-	-	-	-	-	568	556	-	662	630	-
Stage 2	-	-	-	-	-	-	676	626	-	585	543	-
Platoon blocked, %		-	-		-	-						
Mov Cap-1 Maneuver	1174	-	-	1056	-	-	274	279	590	276	273	677
Mov Cap-2 Maneuver	-	-	-	-	-	-	274	279	-	276	273	-
Stage 1	-	-	-	-	-	-	542	530	-	634	610	-
Stage 2	-	-	-	-	-	-	656	606	-	557	518	-

Approach	EB			WB			NB			SB		
HCM Control Delay, s	0.2			0.1			15.6			12.5		
HCM LOS							C			B		

Minor Lane/Major Mvmt	NBLn1	EBL	EBT	EBR	WBL	WBT	WBR	SBLn1
Capacity (veh/h)	378	1174	-	-	1056	-	-	503
HCM Lane V/C Ratio	0.099	0.012	-	-	0.004	-	-	0.044
HCM Control Delay (s)	15.6	8.1	0	-	8.4	0	-	12.5
HCM Lane LOS	C	A	A	-	A	A	-	B
HCM 95th %tile Q(veh)	0.3	0	-	-	0	-	-	0.1

Intersection												
Int Delay, s/veh	0.7											
Movement	EBL	EBT	EBR	WBL	WBT	WBR	NBL	NBT	NBR	SBL	SBT	SBR
Lane Configurations		↗			↖			↔			↔	
Traffic Vol, veh/h	0	407	0	0	333	0	0	0	0	20	0	18
Future Vol, veh/h	0	407	0	0	333	0	0	0	0	20	0	18
Conflicting Peds, #/hr	0	0	27	27	0	0	0	0	0	0	0	0
Sign Control	Free	Free	Free	Free	Free	Free	Stop	Stop	Stop	Stop	Stop	Stop
RT Channelized	-	-	None	-	-	None	-	-	None	-	-	None
Storage Length	-	-	-	-	-	-	-	-	-	-	-	-
Veh in Median Storage, #	-	0	-	-	0	-	-	0	-	-	0	-
Grade, %	-	0	-	-	0	-	-	0	-	-	0	-
Peak Hour Factor	93	93	93	93	93	93	93	93	93	93	93	93
Heavy Vehicles, %	2	2	2	2	2	2	2	2	2	2	2	2
Mvmt Flow	0	438	0	0	358	0	0	0	0	22	0	19

Major/Minor	Major1			Major2			Minor1			Minor2		
Conflicting Flow All	-	0	0	465	0	0	833	823	465	796	823	358
Stage 1	-	-	-	-	-	-	465	465	-	358	358	-
Stage 2	-	-	-	-	-	-	368	358	-	438	465	-
Critical Hdwy	-	-	-	4.12	-	-	7.12	6.52	6.22	7.12	6.52	6.22
Critical Hdwy Stg 1	-	-	-	-	-	-	6.12	5.52	-	6.12	5.52	-
Critical Hdwy Stg 2	-	-	-	-	-	-	6.12	5.52	-	6.12	5.52	-
Follow-up Hdwy	-	-	-	2.218	-	-	3.518	4.018	3.318	3.518	4.018	3.318
Pot Cap-1 Maneuver	0	-	-	1096	-	0	288	309	597	305	309	686
Stage 1	0	-	-	-	-	0	578	563	-	660	628	-
Stage 2	0	-	-	-	-	0	652	628	-	597	563	-
Platoon blocked, %	-	-	-	-	-	-	-	-	-	-	-	-
Mov Cap-1 Maneuver	-	-	-	1068	-	-	273	301	582	305	301	686
Mov Cap-2 Maneuver	-	-	-	-	-	-	273	301	-	305	301	-
Stage 1	-	-	-	-	-	-	578	548	-	660	628	-
Stage 2	-	-	-	-	-	-	634	628	-	597	548	-

Approach	EB	WB	NB	SB
HCM Control Delay, s	0	0	0	14.6
HCM LOS			A	B

Minor Lane/Major Mvmt	NBLn1	EBT	EBR	WBL	WBT	SBLn1
Capacity (veh/h)	-	-	-	1068	-	414
HCM Lane V/C Ratio	-	-	-	-	-	0.099
HCM Control Delay (s)	0	-	-	0	-	14.6
HCM Lane LOS	A	-	-	A	-	B
HCM 95th %tile Q(veh)	-	-	-	0	-	0.3

HCM 6th Signalized Intersection Summary
5: S B St & 9th Ave

Opening Year Plus Project PM
06/09/2023



Movement	EBL	EBT	EBR	WBL	WBT	WBR	NBL	NBT	NBR	SBL	SBT	SBR
Lane Configurations		↔		↔	↔		↔	↔		↔	↔	
Traffic Volume (veh/h)	26	207	11	88	187	76	6	75	126	74	49	33
Future Volume (veh/h)	26	207	11	88	187	76	6	75	126	74	49	33
Initial Q (Qb), veh	0	0	0	0	0	0	0	0	0	0	0	0
Ped-Bike Adj(A_pbT)	0.97		0.93	0.97		0.93	0.98		0.95	0.98		0.95
Parking Bus, Adj	1.00	1.00	1.00	1.00	1.00	1.00	1.00	1.00	1.00	1.00	1.00	1.00
Work Zone On Approach		No			No			No			No	
Adj Sat Flow, veh/h/ln	1870	1870	1870	1870	1870	1870	1870	1870	1870	1870	1870	1870
Adj Flow Rate, veh/h	28	223	9	95	201	60	6	81	63	80	53	16
Peak Hour Factor	0.93	0.93	0.93	0.93	0.93	0.93	0.93	0.93	0.93	0.93	0.93	0.93
Percent Heavy Veh, %	2	2	2	2	2	2	2	2	2	2	2	2
Cap, veh/h	100	658	25	558	547	163	690	444	345	619	634	192
Arrive On Green	0.40	0.40	0.40	0.40	0.40	0.40	0.47	0.47	0.47	0.47	0.47	0.47
Sat Flow, veh/h	94	1630	62	1113	1355	405	1301	952	741	1220	1362	411
Grp Volume(v), veh/h	260	0	0	95	0	261	6	0	144	80	0	69
Grp Sat Flow(s),veh/h/ln	1786	0	0	1113	0	1760	1301	0	1693	1220	0	1773
Q Serve(g_s), s	0.0	0.0	0.0	0.0	0.0	6.7	0.2	0.0	3.2	2.6	0.0	1.4
Cycle Q Clear(g_c), s	6.3	0.0	0.0	3.7	0.0	6.7	1.6	0.0	3.2	5.8	0.0	1.4
Prop In Lane	0.11		0.03	1.00		0.23	1.00		0.44	1.00		0.23
Lane Grp Cap(c), veh/h	783	0	0	558	0	711	690	0	789	619	0	826
V/C Ratio(X)	0.33	0.00	0.00	0.17	0.00	0.37	0.01	0.00	0.18	0.13	0.00	0.08
Avail Cap(c_a), veh/h	783	0	0	558	0	711	690	0	789	619	0	826
HCM Platoon Ratio	1.00	1.00	1.00	1.00	1.00	1.00	1.00	1.00	1.00	1.00	1.00	1.00
Upstream Filter(I)	1.00	0.00	0.00	1.00	0.00	1.00	1.00	0.00	1.00	1.00	0.00	1.00
Uniform Delay (d), s/veh	13.3	0.0	0.0	12.5	0.0	13.4	10.0	0.0	10.0	11.7	0.0	9.6
Incr Delay (d2), s/veh	1.1	0.0	0.0	0.7	0.0	1.5	0.0	0.0	0.5	0.4	0.0	0.2
Initial Q Delay(d3),s/veh	0.0	0.0	0.0	0.0	0.0	0.0	0.0	0.0	0.0	0.0	0.0	0.0
%ile BackOfQ(50%),veh/ln	2.6	0.0	0.0	0.9	0.0	2.7	0.0	0.0	1.2	0.7	0.0	0.5
Unsig. Movement Delay, s/veh												
LnGrp Delay(d),s/veh	14.5	0.0	0.0	13.2	0.0	14.9	10.0	0.0	10.6	12.2	0.0	9.8
LnGrp LOS	B	A	A	B	A	B	B	A	B	B	A	A
Approach Vol, veh/h		260			356			150				149
Approach Delay, s/veh		14.5			14.5			10.5				11.1
Approach LOS		B			B			B				B
Timer - Assigned Phs		2		4		6		8				
Phs Duration (G+Y+Rc), s		30.2		34.2		30.2		34.2				
Change Period (Y+Rc), s		* 4.2		* 4.2		* 4.2		* 4.2				
Max Green Setting (Gmax), s		* 26		* 30		* 26		* 30				
Max Q Clear Time (g_c+I1), s		8.3		5.2		8.7		7.8				
Green Ext Time (p_c), s		0.3		1.2		0.3		0.9				

Intersection Summary

HCM 6th Ctrl Delay	13.3
HCM 6th LOS	B

Notes

* HCM 6th computational engine requires equal clearance times for the phases crossing the barrier.

Intersection	
Intersection Delay, s/veh	12.6
Intersection LOS	B

Movement	EBL	EBT	EBR	WBL	WBT	WBR	NBL	NBT	NBR	SBL	SBT	SBR
Lane Configurations		↕			↕			↕			↕	
Traffic Vol, veh/h	47	208	22	86	291	24	17	107	23	1	53	39
Future Vol, veh/h	47	208	22	86	291	24	17	107	23	1	53	39
Peak Hour Factor	0.99	0.99	0.99	0.99	0.99	0.99	0.99	0.99	0.99	0.99	0.99	0.99
Heavy Vehicles, %	2	2	2	2	2	2	2	2	2	2	2	2
Mvmt Flow	47	210	22	87	294	24	17	108	23	1	54	39
Number of Lanes	0	1	0	0	1	0	0	1	0	0	1	0

Approach	EB	WB	NB	SB
Opposing Approach	WB	EB	SB	NB
Opposing Lanes	1	1	1	1
Conflicting Approach Left	SB	NB	EB	WB
Conflicting Lanes Left	1	1	1	1
Conflicting Approach Right	NB	SB	WB	EB
Conflicting Lanes Right	1	1	1	1
HCM Control Delay	11.8	14.6	10.7	9.8
HCM LOS	B	B	B	A

Lane	NBLn1	EBLn1	WBLn1	SBLn1
Vol Left, %	12%	17%	21%	1%
Vol Thru, %	73%	75%	73%	57%
Vol Right, %	16%	8%	6%	42%
Sign Control	Stop	Stop	Stop	Stop
Traffic Vol by Lane	147	277	401	93
LT Vol	17	47	86	1
Through Vol	107	208	291	53
RT Vol	23	22	24	39
Lane Flow Rate	148	280	405	94
Geometry Grp	1	1	1	1
Degree of Util (X)	0.239	0.405	0.57	0.15
Departure Headway (Hd)	5.79	5.213	5.066	5.736
Convergence, Y/N	Yes	Yes	Yes	Yes
Cap	619	691	713	624
Service Time	3.836	3.249	3.099	3.786
HCM Lane V/C Ratio	0.239	0.405	0.568	0.151
HCM Control Delay	10.7	11.8	14.6	9.8
HCM Lane LOS	B	B	B	A
HCM 95th-tile Q	0.9	2	3.6	0.5

Intersection												
Intersection Delay, s/veh	41.6											
Intersection LOS	E											

Movement	EBL	EBT	EBR	WBL	WBT	WBR	NBL	NBT	NBR	SBL	SBT	SBR
Lane Configurations		↕			↕			↕			↕	
Traffic Vol, veh/h	48	336	96	34	376	21	107	78	19	23	89	49
Future Vol, veh/h	48	336	96	34	376	21	107	78	19	23	89	49
Peak Hour Factor	0.91	0.91	0.91	0.91	0.91	0.91	0.91	0.91	0.91	0.91	0.91	0.91
Heavy Vehicles, %	2	2	2	2	2	2	2	2	2	2	2	2
Mvmt Flow	53	369	105	37	413	23	118	86	21	25	98	54
Number of Lanes	0	1	0	0	1	0	0	1	0	0	1	0

Approach	EB	WB	NB	SB
Opposing Approach	WB	EB	SB	NB
Opposing Lanes	1	1	1	1
Conflicting Approach Left	SB	NB	EB	WB
Conflicting Lanes Left	1	1	1	1
Conflicting Approach Right	NB	SB	WB	EB
Conflicting Lanes Right	1	1	1	1
HCM Control Delay	57.6	44.1	18.6	16.1
HCM LOS	F	E	C	C

Lane	NBLn1	EBLn1	WBLn1	SBLn1
Vol Left, %	52%	10%	8%	14%
Vol Thru, %	38%	70%	87%	55%
Vol Right, %	9%	20%	5%	30%
Sign Control	Stop	Stop	Stop	Stop
Traffic Vol by Lane	204	480	431	161
LT Vol	107	48	34	23
Through Vol	78	336	376	89
RT Vol	19	96	21	49
Lane Flow Rate	224	527	474	177
Geometry Grp	1	1	1	1
Degree of Util (X)	0.494	0.971	0.896	0.391
Departure Headway (Hd)	7.929	6.624	6.814	7.964
Convergence, Y/N	Yes	Yes	Yes	Yes
Cap	453	549	530	449
Service Time	6.014	4.691	4.886	6.059
HCM Lane V/C Ratio	0.494	0.96	0.894	0.394
HCM Control Delay	18.6	57.6	44.1	16.1
HCM Lane LOS	C	F	E	C
HCM 95th-tile Q	2.7	13.1	10.3	1.8

Intersection												
Int Delay, s/veh	1.1											
Movement	EBL	EBT	EBR	WBL	WBT	WBR	NBL	NBT	NBR	SBL	SBT	SBR
Lane Configurations		↕			↕	↕		↕			↕	
Traffic Vol, veh/h	6	456	59	11	517	4	20	0	24	0	0	0
Future Vol, veh/h	6	456	59	11	517	4	20	0	24	0	0	0
Conflicting Peds, #/hr	21	0	33	0	0	21	0	0	0	0	0	0
Sign Control	Free	Free	Free	Free	Free	Free	Stop	Stop	Stop	Stop	Stop	Stop
RT Channelized	-	-	None	-	-	None	-	-	None	-	-	None
Storage Length	-	-	-	-	-	75	-	-	-	-	-	-
Veh in Median Storage, #	-	0	-	-	0	-	-	0	-	-	0	-
Grade, %	-	0	-	-	0	-	-	0	-	-	0	-
Peak Hour Factor	87	87	87	87	87	87	87	87	87	87	87	87
Heavy Vehicles, %	2	2	2	2	2	2	2	2	2	2	2	2
Mvmt Flow	7	524	68	13	594	5	23	0	28	0	0	0

Major/Minor	Major1			Major2			Minor1			Minor2		
Conflicting Flow All	620	0	0	625	0	0	1228	1251	591	1227	1280	615
Stage 1	-	-	-	-	-	-	605	605	-	641	641	-
Stage 2	-	-	-	-	-	-	623	646	-	586	639	-
Critical Hdwy	4.12	-	-	4.12	-	-	7.12	6.52	6.22	7.12	6.52	6.22
Critical Hdwy Stg 1	-	-	-	-	-	-	6.12	5.52	-	6.12	5.52	-
Critical Hdwy Stg 2	-	-	-	-	-	-	6.12	5.52	-	6.12	5.52	-
Follow-up Hdwy	2.218	-	-	2.218	-	-	3.518	4.018	3.318	3.518	4.018	3.318
Pot Cap-1 Maneuver	960	-	-	956	-	-	155	172	507	155	166	491
Stage 1	-	-	-	-	-	-	485	487	-	463	469	-
Stage 2	-	-	-	-	-	-	474	467	-	496	470	-
Platoon blocked, %		-	-		-	-						
Mov Cap-1 Maneuver	941	-	-	926	-	-	146	158	491	140	153	481
Mov Cap-2 Maneuver	-	-	-	-	-	-	146	158	-	140	153	-
Stage 1	-	-	-	-	-	-	465	467	-	449	450	-
Stage 2	-	-	-	-	-	-	464	448	-	463	450	-

Approach	EB			WB			NB			SB		
HCM Control Delay, s	0.1			0.2			24.3			0		
HCM LOS							C			A		

Minor Lane/Major Mvmt	NBLn1	EBL	EBT	EBR	WBL	WBT	WBR	SBLn1
Capacity (veh/h)	237	941	-	-	926	-	-	-
HCM Lane V/C Ratio	0.213	0.007	-	-	0.014	-	-	-
HCM Control Delay (s)	24.3	8.9	0	-	8.9	0	-	0
HCM Lane LOS	C	A	A	-	A	A	-	A
HCM 95th %tile Q(veh)	0.8	0	-	-	0	-	-	-

Intersection												
Int Delay, s/veh	0.4											
Movement	EBL	EBT	EBR	WBL	WBT	WBR	NBL	NBT	NBR	SBL	SBT	SBR
Lane Configurations		↗			↖			↔			↔	
Traffic Vol, veh/h	0	509	5	3	534	0	1	0	3	9	0	9
Future Vol, veh/h	0	509	5	3	534	0	1	0	3	9	0	9
Conflicting Peds, #/hr	0	0	29	29	0	0	0	0	0	0	0	0
Sign Control	Free	Free	Free	Free	Free	Free	Stop	Stop	Stop	Stop	Stop	Stop
RT Channelized	-	-	None	-	-	None	-	-	None	-	-	None
Storage Length	-	-	-	-	-	-	-	-	-	-	-	-
Veh in Median Storage, #	-	0	-	-	0	-	-	0	-	-	0	-
Grade, %	-	0	-	-	0	-	-	0	-	-	0	-
Peak Hour Factor	86	86	86	86	86	86	86	86	86	86	86	86
Heavy Vehicles, %	2	2	2	2	2	2	2	2	2	2	2	2
Mvmt Flow	0	592	6	3	621	0	1	0	3	10	0	10



















Major/Minor	Major1			Major2			Minor1			Minor2		
Conflicting Flow All	-	0	0	627	0	0	1256	1251	624	1224	1254	621
Stage 1	-	-	-	-	-	-	624	624	-	627	627	-
Stage 2	-	-	-	-	-	-	632	627	-	597	627	-
Critical Hdwy	-	-	-	4.12	-	-	7.12	6.52	6.22	7.12	6.52	6.22
Critical Hdwy Stg 1	-	-	-	-	-	-	6.12	5.52	-	6.12	5.52	-
Critical Hdwy Stg 2	-	-	-	-	-	-	6.12	5.52	-	6.12	5.52	-
Follow-up Hdwy	-	-	-	2.218	-	-	3.518	4.018	3.318	3.518	4.018	3.318
Pot Cap-1 Maneuver	0	-	-	955	-	0	148	172	485	156	172	487
Stage 1	0	-	-	-	-	0	473	478	-	471	476	-
Stage 2	0	-	-	-	-	0	468	476	-	490	476	-
Platoon blocked, %	-	-	-	-	-	-	-	-	-	-	-	-
Mov Cap-1 Maneuver	-	-	-	929	-	-	140	166	472	154	166	487
Mov Cap-2 Maneuver	-	-	-	-	-	-	140	166	-	154	166	-
Stage 1	-	-	-	-	-	-	473	465	-	471	474	-
Stage 2	-	-	-	-	-	-	456	474	-	486	463	-

Approach	EB			WB			NB			SB		
HCM Control Delay, s	0			0			17.4			21.9		
HCM LOS							C			C		

Minor Lane/Major Mvmt	NBLn1	EBT	EBR	WBL	WBT	SBLn1
Capacity (veh/h)	296	-	-	929	-	234
HCM Lane V/C Ratio	0.016	-	-	0.004	-	0.089
HCM Control Delay (s)	17.4	-	-	8.9	0	21.9
HCM Lane LOS	C	-	-	A	A	C
HCM 95th %tile Q(veh)	0	-	-	0	-	0.3

HCM 6th Signalized Intersection Summary
5: S B St & 9th Ave

Cumulative AM
06/09/2023

												
Movement	EBL	EBT	EBR	WBL	WBT	WBR	NBL	NBT	NBR	SBL	SBT	SBR
Lane Configurations												
Traffic Volume (veh/h)	56	211	10	119	304	121	11	300	211	92	235	69
Future Volume (veh/h)	56	211	10	119	304	121	11	300	211	92	235	69
Initial Q (Qb), veh	0	0	0	0	0	0	0	0	0	0	0	0
Ped-Bike Adj(A_pbT)	0.99		0.98	0.99		0.95	0.99		0.96	0.99		1.00
Parking Bus, Adj	1.00	1.00	1.00	1.00	1.00	1.00	1.00	1.00	1.00	1.00	1.00	1.00
Work Zone On Approach		No			No			No			No	
Adj Sat Flow, veh/h/ln	1870	1870	1870	1870	1870	1870	1870	1870	1870	1870	1870	1870
Adj Flow Rate, veh/h	64	243	8	137	349	106	13	345	181	106	270	-47
Peak Hour Factor	0.87	0.87	0.87	0.87	0.87	0.87	0.87	0.87	0.87	0.87	0.87	0.87
Percent Heavy Veh, %	2	2	2	2	2	2	2	2	2	2	2	2
Cap, veh/h	129	445	13	442	548	167	563	531	278	316	871	0
Arrive On Green	0.40	0.40	0.40	0.40	0.40	0.40	0.47	0.47	0.47	0.47	0.47	0.00
Sat Flow, veh/h	153	1101	33	1117	1358	412	1146	1139	598	872	1870	0
Grp Volume(v), veh/h	315	0	0	137	0	455	13	0	526	106	223	0
Grp Sat Flow(s),veh/h/ln	1287	0	0	1117	0	1771	1146	0	1737	872	1870	0
Q Serve(g_s), s	2.0	0.0	0.0	0.0	0.0	13.3	0.4	0.0	14.9	6.8	4.7	0.0
Cycle Q Clear(g_c), s	15.3	0.0	0.0	11.2	0.0	13.3	5.1	0.0	14.9	21.8	4.7	0.0
Prop In Lane	0.20		0.03	1.00		0.23	1.00		0.34	1.00		0.00
Lane Grp Cap(c), veh/h	587	0	0	442	0	715	563	0	809	316	871	0
V/C Ratio(X)	0.54	0.00	0.00	0.31	0.00	0.64	0.02	0.00	0.65	0.34	0.26	0.00
Avail Cap(c_a), veh/h	587	0	0	442	0	715	563	0	809	316	871	0
HCM Platoon Ratio	1.00	1.00	1.00	1.00	1.00	1.00	1.00	1.00	1.00	1.00	1.00	1.00
Upstream Filter(I)	1.00	0.00	0.00	1.00	0.00	1.00	1.00	0.00	1.00	1.00	1.00	0.00
Uniform Delay (d), s/veh	14.3	0.0	0.0	14.8	0.0	15.4	12.0	0.0	13.2	21.5	10.4	0.0
Incr Delay (d2), s/veh	3.5	0.0	0.0	1.8	0.0	4.3	0.1	0.0	4.0	2.9	0.7	0.0
Initial Q Delay(d3),s/veh	0.0	0.0	0.0	0.0	0.0	0.0	0.0	0.0	0.0	0.0	0.0	0.0
%ile BackOfQ(50%),veh/ln	3.5	0.0	0.0	1.6	0.0	5.6	0.1	0.0	5.9	1.6	1.9	0.0
Unsig. Movement Delay, s/veh												
LnGrp Delay(d),s/veh	17.8	0.0	0.0	16.6	0.0	19.7	12.1	0.0	17.2	24.4	11.1	0.0
LnGrp LOS	B	A	A	B	A	B	B	A	B	C	B	A
Approach Vol, veh/h		315			592			539			329	
Approach Delay, s/veh		17.8			19.0			17.1			15.4	
Approach LOS		B			B			B			B	
Timer - Assigned Phs		2		4		6		8				
Phs Duration (G+Y+Rc), s		30.2		34.2		30.2		34.2				
Change Period (Y+Rc), s		* 4.2		* 4.2		* 4.2		* 4.2				
Max Green Setting (Gmax), s		* 26		* 30		* 26		* 30				
Max Q Clear Time (g_c+I1), s		17.3		16.9		15.3		23.8				
Green Ext Time (p_c), s		0.3		4.0		0.5		1.3				
Intersection Summary												
HCM 6th Ctrl Delay				17.5								
HCM 6th LOS				B								
Notes												
* HCM 6th computational engine requires equal clearance times for the phases crossing the barrier.												

Intersection	
Intersection Delay, s/veh	20.7
Intersection LOS	C

Movement	EBL	EBT	EBR	WBL	WBT	WBR	NBL	NBT	NBR	SBL	SBT	SBR
Lane Configurations		↕			↕			↕			↕	
Traffic Vol, veh/h	64	377	23	29	293	24	14	71	31	11	77	35
Future Vol, veh/h	64	377	23	29	293	24	14	71	31	11	77	35
Peak Hour Factor	0.88	0.88	0.88	0.88	0.88	0.88	0.88	0.88	0.88	0.88	0.88	0.88
Heavy Vehicles, %	2	2	2	2	2	2	2	2	2	2	2	2
Mvmt Flow	73	428	26	33	333	27	16	81	35	13	88	40
Number of Lanes	0	1	0	0	1	0	0	1	0	0	1	0

Approach	EB	WB	NB	SB
Opposing Approach	WB	EB	SB	NB
Opposing Lanes	1	1	1	1
Conflicting Approach Left	SB	NB	EB	WB
Conflicting Lanes Left	1	1	1	1
Conflicting Approach Right	NB	SB	WB	EB
Conflicting Lanes Right	1	1	1	1
HCM Control Delay	27.2	17.9	11.9	12
HCM LOS	D	C	B	B

Lane	NBLn1	EBLn1	WBLn1	SBLn1
Vol Left, %	12%	14%	8%	9%
Vol Thru, %	61%	81%	85%	63%
Vol Right, %	27%	5%	7%	28%
Sign Control	Stop	Stop	Stop	Stop
Traffic Vol by Lane	116	464	346	123
LT Vol	14	64	29	11
Through Vol	71	377	293	77
RT Vol	31	23	24	35
Lane Flow Rate	132	527	393	140
Geometry Grp	1	1	1	1
Degree of Util (X)	0.246	0.801	0.628	0.259
Departure Headway (Hd)	6.722	5.578	5.748	6.68
Convergence, Y/N	Yes	Yes	Yes	Yes
Cap	535	654	633	538
Service Time	4.751	3.578	3.748	4.708
HCM Lane V/C Ratio	0.247	0.806	0.621	0.26
HCM Control Delay	11.9	27.2	17.9	12
HCM Lane LOS	B	D	C	B
HCM 95th-tile Q	1	8	4.4	1

Intersection												
Intersection Delay, s/veh	17											
Intersection LOS	C											

Movement	EBL	EBT	EBR	WBL	WBT	WBR	NBL	NBT	NBR	SBL	SBT	SBR
Lane Configurations		↕			↕			↕			↕	
Traffic Vol, veh/h	47	351	83	27	293	17	53	52	36	23	52	54
Future Vol, veh/h	47	351	83	27	293	17	53	52	36	23	52	54
Peak Hour Factor	0.97	0.97	0.97	0.97	0.97	0.97	0.97	0.97	0.97	0.97	0.97	0.97
Heavy Vehicles, %	2	2	2	2	2	2	2	2	2	2	2	2
Mvmt Flow	48	362	86	28	302	18	55	54	37	24	54	56
Number of Lanes	0	1	0	0	1	0	0	1	0	0	1	0

Approach	EB	WB	NB	SB
Opposing Approach	WB	EB	SB	NB
Opposing Lanes	1	1	1	1
Conflicting Approach Left	SB	NB	EB	WB
Conflicting Lanes Left	1	1	1	1
Conflicting Approach Right	NB	SB	WB	EB
Conflicting Lanes Right	1	1	1	1
HCM Control Delay	21.4	15	11.7	11.3
HCM LOS	C	B	B	B

Lane	NBLn1	EBLn1	WBLn1	SBLn1
Vol Left, %	38%	10%	8%	18%
Vol Thru, %	37%	73%	87%	40%
Vol Right, %	26%	17%	5%	42%
Sign Control	Stop	Stop	Stop	Stop
Traffic Vol by Lane	141	481	337	129
LT Vol	53	47	27	23
Through Vol	52	351	293	52
RT Vol	36	83	17	54
Lane Flow Rate	145	496	347	133
Geometry Grp	1	1	1	1
Degree of Util (X)	0.258	0.729	0.538	0.232
Departure Headway (Hd)	6.381	5.295	5.57	6.283
Convergence, Y/N	Yes	Yes	Yes	Yes
Cap	558	679	643	567
Service Time	4.476	3.362	3.644	4.381
HCM Lane V/C Ratio	0.26	0.73	0.54	0.235
HCM Control Delay	11.7	21.4	15	11.3
HCM Lane LOS	B	C	B	B
HCM 95th-tile Q	1	6.3	3.2	0.9

Intersection												
Int Delay, s/veh	1											
Movement	EBL	EBT	EBR	WBL	WBT	WBR	NBL	NBT	NBR	SBL	SBT	SBR
Lane Configurations		↕			↕	↕		↕			↕	
Traffic Vol, veh/h	1	457	48	5	394	1	23	0	24	0	0	0
Future Vol, veh/h	1	457	48	5	394	1	23	0	24	0	0	0
Conflicting Peds, #/hr	28	0	32	32	0	28	0	0	0	0	0	0
Sign Control	Free	Free	Free	Free	Free	Free	Stop	Stop	Stop	Stop	Stop	Stop
RT Channelized	-	-	None	-	-	None	-	-	None	-	-	None
Storage Length	-	-	-	-	-	75	-	-	-	-	-	-
Veh in Median Storage, #	-	0	-	-	0	-	-	0	-	-	0	-
Grade, %	-	0	-	-	0	-	-	0	-	-	0	-
Peak Hour Factor	94	94	94	94	94	94	94	94	94	94	94	94
Heavy Vehicles, %	2	2	2	2	2	2	2	2	2	2	2	2
Mvmt Flow	1	486	51	5	419	1	24	0	26	0	0	0

Major/Minor	Major1			Major2			Minor1			Minor2		
Conflicting Flow All	448	0	0	569	0	0	976	1004	544	984	1028	447
Stage 1	-	-	-	-	-	-	546	546	-	457	457	-
Stage 2	-	-	-	-	-	-	430	458	-	527	571	-
Critical Hdwy	4.12	-	-	4.12	-	-	7.12	6.52	6.22	7.12	6.52	6.22
Critical Hdwy Stg 1	-	-	-	-	-	-	6.12	5.52	-	6.12	5.52	-
Critical Hdwy Stg 2	-	-	-	-	-	-	6.12	5.52	-	6.12	5.52	-
Follow-up Hdwy	2.218	-	-	2.218	-	-	3.518	4.018	3.318	3.518	4.018	3.318
Pot Cap-1 Maneuver	1112	-	-	1003	-	-	230	242	539	228	234	612
Stage 1	-	-	-	-	-	-	522	518	-	583	568	-
Stage 2	-	-	-	-	-	-	603	567	-	535	505	-
Platoon blocked, %		-	-		-	-						
Mov Cap-1 Maneuver	1082	-	-	972	-	-	222	227	523	210	219	596
Mov Cap-2 Maneuver	-	-	-	-	-	-	222	227	-	210	219	-
Stage 1	-	-	-	-	-	-	506	502	-	567	549	-
Stage 2	-	-	-	-	-	-	599	548	-	508	489	-

Approach	EB			WB			NB			SB		
HCM Control Delay, s	0			0.1			18.6			0		
HCM LOS							C			A		

Minor Lane/Major Mvmt	NBLn1	EBL	EBT	EBR	WBL	WBT	WBR	SBLn1
Capacity (veh/h)	314	1082	-	-	972	-	-	-
HCM Lane V/C Ratio	0.159	0.001	-	-	0.005	-	-	-
HCM Control Delay (s)	18.6	8.3	0	-	8.7	0	-	0
HCM Lane LOS	C	A	A	-	A	A	-	A
HCM 95th %tile Q(veh)	0.6	0	-	-	0	-	-	-

Intersection												
Int Delay, s/veh	1											
Movement	EBL	EBT	EBR	WBL	WBT	WBR	NBL	NBT	NBR	SBL	SBT	SBR
Lane Configurations		↗			↖			↔			↔	
Traffic Vol, veh/h	0	479	0	0	417	0	0	0	0	27	0	24
Future Vol, veh/h	0	479	0	0	417	0	0	0	0	27	0	24
Conflicting Peds, #/hr	0	0	27	27	0	0	0	0	0	0	0	0
Sign Control	Free	Free	Free	Free	Free	Free	Stop	Stop	Stop	Stop	Stop	Stop
RT Channelized	-	-	None	-	-	None	-	-	None	-	-	None
Storage Length	-	-	-	-	-	-	-	-	-	-	-	-
Veh in Median Storage, #	-	0	-	-	0	-	-	0	-	-	0	-
Grade, %	-	0	-	-	0	-	-	0	-	-	0	-
Peak Hour Factor	93	93	93	93	93	93	93	93	93	93	93	93
Heavy Vehicles, %	2	2	2	2	2	2	2	2	2	2	2	2
Mvmt Flow	0	515	0	0	448	0	0	0	0	29	0	26

Major/Minor	Major1			Major2			Minor1			Minor2		
Conflicting Flow All	-	0	0	542	0	0	1003	990	542	963	990	448
Stage 1	-	-	-	-	-	-	542	542	-	448	448	-
Stage 2	-	-	-	-	-	-	461	448	-	515	542	-
Critical Hdwy	-	-	-	4.12	-	-	7.12	6.52	6.22	7.12	6.52	6.22
Critical Hdwy Stg 1	-	-	-	-	-	-	6.12	5.52	-	6.12	5.52	-
Critical Hdwy Stg 2	-	-	-	-	-	-	6.12	5.52	-	6.12	5.52	-
Follow-up Hdwy	-	-	-	2.218	-	-	3.518	4.018	3.318	3.518	4.018	3.318
Pot Cap-1 Maneuver	0	-	-	1027	-	0	221	246	540	235	246	611
Stage 1	0	-	-	-	-	0	525	520	-	590	573	-
Stage 2	0	-	-	-	-	0	581	573	-	543	520	-
Platoon blocked, %	-	-	-	-	-	-	-	-	-	-	-	-
Mov Cap-1 Maneuver	-	-	-	1001	-	-	206	240	526	235	240	611
Mov Cap-2 Maneuver	-	-	-	-	-	-	206	240	-	235	240	-
Stage 1	-	-	-	-	-	-	525	506	-	590	573	-
Stage 2	-	-	-	-	-	-	556	573	-	543	506	-

Approach	EB	WB	NB	SB
HCM Control Delay, s	0	0	0	18
HCM LOS			A	C

Minor Lane/Major Mvmt	NBLn1	EBT	EBR	WBL	WBT	SBLn1
Capacity (veh/h)	-	-	-	1001	-	331
HCM Lane V/C Ratio	-	-	-	-	-	0.166
HCM Control Delay (s)	0	-	-	0	-	18
HCM Lane LOS	A	-	-	A	-	C
HCM 95th %tile Q(veh)	-	-	-	0	-	0.6

HCM 6th Signalized Intersection Summary
5: S B St & 9th Ave

Cumulative PM
06/09/2023



Movement	EBL	EBT	EBR	WBL	WBT	WBR	NBL	NBT	NBR	SBL	SBT	SBR
Lane Configurations		↔		↔	↔		↔	↔		↔	↔	
Traffic Volume (veh/h)	68	195	27	133	192	116	9	302	140	144	345	97
Future Volume (veh/h)	68	195	27	133	192	116	9	302	140	144	345	97
Initial Q (Qb), veh	0	0	0	0	0	0	0	0	0	0	0	0
Ped-Bike Adj(A_pbT)	0.97		0.93	0.97		0.93	0.99		0.95	0.99		0.95
Parking Bus, Adj	1.00	1.00	1.00	1.00	1.00	1.00	1.00	1.00	1.00	1.00	1.00	1.00
Work Zone On Approach		No			No			No			No	
Adj Sat Flow, veh/h/ln	1870	1870	1870	1870	1870	1870	1870	1870	1870	1870	1870	1870
Adj Flow Rate, veh/h	73	210	28	143	206	81	10	325	117	155	371	63
Peak Hour Factor	0.93	0.93	0.93	0.93	0.93	0.93	0.93	0.93	0.93	0.93	0.93	0.93
Percent Heavy Veh, %	2	2	2	2	2	2	2	2	2	2	2	2
Cap, veh/h	173	463	56	516	503	198	392	602	217	380	720	122
Arrive On Green	0.40	0.40	0.40	0.40	0.40	0.40	0.47	0.47	0.47	0.47	0.47	0.47
Sat Flow, veh/h	258	1147	139	1110	1247	490	944	1293	466	937	1546	262
Grp Volume(v), veh/h	311	0	0	143	0	287	10	0	442	155	0	434
Grp Sat Flow(s),veh/h/ln	1544	0	0	1110	0	1737	944	0	1759	937	0	1808
Q Serve(g_s), s	2.2	0.0	0.0	0.0	0.0	7.6	0.5	0.0	11.5	9.1	0.0	10.9
Cycle Q Clear(g_c), s	9.8	0.0	0.0	8.1	0.0	7.6	11.3	0.0	11.5	20.7	0.0	10.9
Prop In Lane	0.23		0.09	1.00		0.28	1.00		0.26	1.00		0.15
Lane Grp Cap(c), veh/h	692	0	0	516	0	701	392	0	819	380	0	842
V/C Ratio(X)	0.45	0.00	0.00	0.28	0.00	0.41	0.03	0.00	0.54	0.41	0.00	0.52
Avail Cap(c_a), veh/h	692	0	0	516	0	701	392	0	819	380	0	842
HCM Platoon Ratio	1.00	1.00	1.00	1.00	1.00	1.00	1.00	1.00	1.00	1.00	1.00	1.00
Upstream Filter(I)	1.00	0.00	0.00	1.00	0.00	1.00	1.00	0.00	1.00	1.00	0.00	1.00
Uniform Delay (d), s/veh	14.0	0.0	0.0	13.9	0.0	13.7	16.1	0.0	12.3	19.6	0.0	12.1
Incr Delay (d2), s/veh	2.1	0.0	0.0	1.3	0.0	1.8	0.1	0.0	2.5	3.2	0.0	2.2
Initial Q Delay(d3),s/veh	0.0	0.0	0.0	0.0	0.0	0.0	0.0	0.0	0.0	0.0	0.0	0.0
%ile BackOfQ(50%),veh/ln	3.3	0.0	0.0	1.5	0.0	3.0	0.1	0.0	4.5	2.2	0.0	4.3
Unsig. Movement Delay, s/veh												
LnGrp Delay(d),s/veh	16.1	0.0	0.0	15.2	0.0	15.5	16.2	0.0	14.8	22.9	0.0	14.3
LnGrp LOS	B	A	A	B	A	B	B	A	B	C	A	B
Approach Vol, veh/h		311			430			452			589	
Approach Delay, s/veh		16.1			15.4			14.8			16.6	
Approach LOS		B			B			B			B	
Timer - Assigned Phs		2		4		6		8				
Phs Duration (G+Y+Rc), s		30.2		34.2		30.2		34.2				
Change Period (Y+Rc), s		* 4.2		* 4.2		* 4.2		* 4.2				
Max Green Setting (Gmax), s		* 26		* 30		* 26		* 30				
Max Q Clear Time (g_c+I1), s		11.8		13.5		10.1		22.7				
Green Ext Time (p_c), s		0.4		3.7		0.3		2.8				

Intersection Summary

HCM 6th Ctrl Delay	15.8
HCM 6th LOS	B

Notes

* HCM 6th computational engine requires equal clearance times for the phases crossing the barrier.

Intersection	
Intersection Delay, s/veh	12.9
Intersection LOS	B

Movement	EBL	EBT	EBR	WBL	WBT	WBR	NBL	NBT	NBR	SBL	SBT	SBR
Lane Configurations		↕			↕			↕			↕	
Traffic Vol, veh/h	47	208	23	87	291	24	21	112	25	1	56	39
Future Vol, veh/h	47	208	23	87	291	24	21	112	25	1	56	39
Peak Hour Factor	0.99	0.99	0.99	0.99	0.99	0.99	0.99	0.99	0.99	0.99	0.99	0.99
Heavy Vehicles, %	2	2	2	2	2	2	2	2	2	2	2	2
Mvmt Flow	47	210	23	88	294	24	21	113	25	1	57	39
Number of Lanes	0	1	0	0	1	0	0	1	0	0	1	0

Approach	EB	WB	NB	SB
Opposing Approach	WB	EB	SB	NB
Opposing Lanes	1	1	1	1
Conflicting Approach Left	SB	NB	EB	WB
Conflicting Lanes Left	1	1	1	1
Conflicting Approach Right	NB	SB	WB	EB
Conflicting Lanes Right	1	1	1	1
HCM Control Delay	12	15	10.9	9.9
HCM LOS	B	B	B	A

Lane	NBLn1	EBLn1	WBLn1	SBLn1
Vol Left, %	13%	17%	22%	1%
Vol Thru, %	71%	75%	72%	58%
Vol Right, %	16%	8%	6%	41%
Sign Control	Stop	Stop	Stop	Stop
Traffic Vol by Lane	158	278	402	96
LT Vol	21	47	87	1
Through Vol	112	208	291	56
RT Vol	25	23	24	39
Lane Flow Rate	160	281	406	97
Geometry Grp	1	1	1	1
Degree of Util (X)	0.258	0.411	0.578	0.156
Departure Headway (Hd)	5.821	5.269	5.121	5.791
Convergence, Y/N	Yes	Yes	Yes	Yes
Cap	616	682	702	617
Service Time	3.872	3.31	3.158	3.848
HCM Lane V/C Ratio	0.26	0.412	0.578	0.157
HCM Control Delay	10.9	12	15	9.9
HCM Lane LOS	B	B	B	A
HCM 95th-tile Q	1	2	3.7	0.5

Intersection												
Intersection Delay, s/veh	45.2											
Intersection LOS	E											

Movement	EBL	EBT	EBR	WBL	WBT	WBR	NBL	NBT	NBR	SBL	SBT	SBR
Lane Configurations		↔			↔			↔			↔	
Traffic Vol, veh/h	48	338	99	34	379	21	109	79	19	23	89	53
Future Vol, veh/h	48	338	99	34	379	21	109	79	19	23	89	53
Peak Hour Factor	0.91	0.91	0.91	0.91	0.91	0.91	0.91	0.91	0.91	0.91	0.91	0.91
Heavy Vehicles, %	2	2	2	2	2	2	2	2	2	2	2	2
Mvmt Flow	53	371	109	37	416	23	120	87	21	25	98	58
Number of Lanes	0	1	0	0	1	0	0	1	0	0	1	0

Approach	EB	WB	NB	SB
Opposing Approach	WB	EB	SB	NB
Opposing Lanes	1	1	1	1
Conflicting Approach Left	SB	NB	EB	WB
Conflicting Lanes Left	1	1	1	1
Conflicting Approach Right	NB	SB	WB	EB
Conflicting Lanes Right	1	1	1	1
HCM Control Delay	63.4	47.9	19.4	16.8
HCM LOS	F	E	C	C

Lane	NBLn1	EBLn1	WBLn1	SBLn1
Vol Left, %	53%	10%	8%	14%
Vol Thru, %	38%	70%	87%	54%
Vol Right, %	9%	20%	5%	32%
Sign Control	Stop	Stop	Stop	Stop
Traffic Vol by Lane	207	485	434	165
LT Vol	109	48	34	23
Through Vol	79	338	379	89
RT Vol	19	99	21	53
Lane Flow Rate	227	533	477	181
Geometry Grp	1	1	1	1
Degree of Util (X)	0.514	0.993	0.915	0.411
Departure Headway (Hd)	8.142	6.813	7.017	8.164
Convergence, Y/N	Yes	Yes	Yes	Yes
Cap	446	538	520	442
Service Time	6.142	4.813	5.017	6.179
HCM Lane V/C Ratio	0.509	0.991	0.917	0.41
HCM Control Delay	19.4	63.4	47.9	16.8
HCM Lane LOS	C	F	E	C
HCM 95th-tile Q	2.9	13.8	10.8	2

Intersection												
Int Delay, s/veh	1.5											
Movement	EBL	EBT	EBR	WBL	WBT	WBR	NBL	NBT	NBR	SBL	SBT	SBR
Lane Configurations		↕			↕	↕		↕			↕	
Traffic Vol, veh/h	20	456	59	11	517	13	20	0	24	5	0	11
Future Vol, veh/h	20	456	59	11	517	13	20	0	24	5	0	11
Conflicting Peds, #/hr	21	0	33	0	0	21	0	0	0	0	0	0
Sign Control	Free	Free	Free	Free	Free	Free	Stop	Stop	Stop	Stop	Stop	Stop
RT Channelized	-	-	None	-	-	None	-	-	None	-	-	None
Storage Length	-	-	-	-	-	75	-	-	-	-	-	-
Veh in Median Storage, #	-	0	-	-	0	-	-	0	-	-	0	-
Grade, %	-	0	-	-	0	-	-	0	-	-	0	-
Peak Hour Factor	87	87	87	87	87	87	87	87	87	87	87	87
Heavy Vehicles, %	2	2	2	2	2	2	2	2	2	2	2	2
Mvmt Flow	23	524	68	13	594	15	23	0	28	6	0	13

Major/Minor	Major1		Major2		Minor1			Minor2				
Conflicting Flow All	630	0	0	625	0	0	1271	1293	591	1259	1312	615
Stage 1	-	-	-	-	-	-	637	637	-	641	641	-
Stage 2	-	-	-	-	-	-	634	656	-	618	671	-
Critical Hdwy	4.12	-	-	4.12	-	-	7.12	6.52	6.22	7.12	6.52	6.22
Critical Hdwy Stg 1	-	-	-	-	-	-	6.12	5.52	-	6.12	5.52	-
Critical Hdwy Stg 2	-	-	-	-	-	-	6.12	5.52	-	6.12	5.52	-
Follow-up Hdwy	2.218	-	-	2.218	-	-	3.518	4.018	3.318	3.518	4.018	3.318
Pot Cap-1 Maneuver	952	-	-	956	-	-	145	163	507	147	159	491
Stage 1	-	-	-	-	-	-	465	471	-	463	469	-
Stage 2	-	-	-	-	-	-	467	462	-	477	455	-
Platoon blocked, %		-	-		-	-						
Mov Cap-1 Maneuver	933	-	-	926	-	-	131	146	491	130	142	481
Mov Cap-2 Maneuver	-	-	-	-	-	-	131	146	-	130	142	-
Stage 1	-	-	-	-	-	-	434	439	-	437	450	-
Stage 2	-	-	-	-	-	-	445	443	-	434	425	-

Approach	EB		WB		NB		SB	
HCM Control Delay, s	0.3		0.2		26.4		19.8	
HCM LOS					D		C	

Minor Lane/Major Mvmt	NBLn1	EBL	EBT	EBR	WBL	WBT	WBR	SBLn1
Capacity (veh/h)	218	933	-	-	926	-	-	261
HCM Lane V/C Ratio	0.232	0.025	-	-	0.014	-	-	0.07
HCM Control Delay (s)	26.4	9	0	-	8.9	0	-	19.8
HCM Lane LOS	D	A	A	-	A	A	-	C
HCM 95th %tile Q(veh)	0.9	0.1	-	-	0	-	-	0.2

Intersection												
Int Delay, s/veh	0.4											
Movement	EBL	EBT	EBR	WBL	WBT	WBR	NBL	NBT	NBR	SBL	SBT	SBR
Lane Configurations		↗			↖			↔			↔	
Traffic Vol, veh/h	0	523	5	3	545	0	1	0	3	9	0	9
Future Vol, veh/h	0	523	5	3	545	0	1	0	3	9	0	9
Conflicting Peds, #/hr	0	0	29	29	0	0	0	0	0	0	0	0
Sign Control	Free	Free	Free	Free	Free	Free	Stop	Stop	Stop	Stop	Stop	Stop
RT Channelized	-	-	None	-	-	None	-	-	None	-	-	None
Storage Length	-	-	-	-	-	-	-	-	-	-	-	-
Veh in Median Storage, #	-	0	-	-	0	-	-	0	-	-	0	-
Grade, %	-	0	-	-	0	-	-	0	-	-	0	-
Peak Hour Factor	86	86	86	86	86	86	86	86	86	86	86	86
Heavy Vehicles, %	2	2	2	2	2	2	2	2	2	2	2	2
Mvmt Flow	0	608	6	3	634	0	1	0	3	10	0	10

Major/Minor	Major1			Major2			Minor1			Minor2		
Conflicting Flow All	-	0	0	643	0	0	1285	1280	640	1253	1283	634
Stage 1	-	-	-	-	-	-	640	640	-	640	640	-
Stage 2	-	-	-	-	-	-	645	640	-	613	643	-
Critical Hdwy	-	-	-	4.12	-	-	7.12	6.52	6.22	7.12	6.52	6.22
Critical Hdwy Stg 1	-	-	-	-	-	-	6.12	5.52	-	6.12	5.52	-
Critical Hdwy Stg 2	-	-	-	-	-	-	6.12	5.52	-	6.12	5.52	-
Follow-up Hdwy	-	-	-	2.218	-	-	3.518	4.018	3.318	3.518	4.018	3.318
Pot Cap-1 Maneuver	0	-	-	942	-	0	142	166	475	149	165	479
Stage 1	0	-	-	-	-	0	464	470	-	464	470	-
Stage 2	0	-	-	-	-	0	461	470	-	480	468	-
Platoon blocked, %	-	-	-	-	-	-	-	-	-	-	-	-
Mov Cap-1 Maneuver	-	-	-	916	-	-	135	161	462	147	160	479
Mov Cap-2 Maneuver	-	-	-	-	-	-	135	161	-	147	160	-
Stage 1	-	-	-	-	-	-	464	457	-	464	468	-
Stage 2	-	-	-	-	-	-	449	468	-	476	455	-

Approach	EB			WB			NB			SB		
HCM Control Delay, s	0			0			17.7			22.6		
HCM LOS							C			C		

Minor Lane/Major Mvmt	NBLn1	EBT	EBR	WBL	WBT	SBLn1
Capacity (veh/h)	288	-	-	916	-	225
HCM Lane V/C Ratio	0.016	-	-	0.004	-	0.093
HCM Control Delay (s)	17.7	-	-	8.9	0	22.6
HCM Lane LOS	C	-	-	A	A	C
HCM 95th %tile Q(veh)	0	-	-	0	-	0.3

HCM 6th Signalized Intersection Summary
5: S B St & 9th Ave

Cumulative Plus Project AM
06/09/2023



Movement	EBL	EBT	EBR	WBL	WBT	WBR	NBL	NBT	NBR	SBL	SBT	SBR
Lane Configurations		↔		↖	↗		↖	↗		↖	↗	
Traffic Volume (veh/h)	56	218	10	119	310	126	11	300	213	97	235	69
Future Volume (veh/h)	56	218	10	119	310	126	11	300	213	97	235	69
Initial Q (Qb), veh	0	0	0	0	0	0	0	0	0	0	0	0
Ped-Bike Adj(A_pbT)	0.99		0.98	0.99		0.95	0.99		0.96	0.99		1.00
Parking Bus, Adj	1.00	1.00	1.00	1.00	1.00	1.00	1.00	1.00	1.00	1.00	1.00	1.00
Work Zone On Approach		No			No			No			No	
Adj Sat Flow, veh/h/ln	1870	1870	1870	1870	1870	1870	1870	1870	1870	1870	1870	1870
Adj Flow Rate, veh/h	64	251	8	137	356	109	13	345	183	111	270	-47
Peak Hour Factor	0.87	0.87	0.87	0.87	0.87	0.87	0.87	0.87	0.87	0.87	0.87	0.87
Percent Heavy Veh, %	2	2	2	2	2	2	2	2	2	2	2	2
Cap, veh/h	126	445	13	432	547	168	563	528	280	314	871	0
Arrive On Green	0.40	0.40	0.40	0.40	0.40	0.40	0.47	0.47	0.47	0.47	0.47	0.00
Sat Flow, veh/h	145	1102	32	1109	1355	415	1146	1134	602	871	1870	0
Grp Volume(v), veh/h	323	0	0	137	0	465	13	0	528	111	223	0
Grp Sat Flow(s),veh/h/ln	1279	0	0	1109	0	1770	1146	0	1736	871	1870	0
Q Serve(g_s), s	2.1	0.0	0.0	0.0	0.0	13.7	0.4	0.0	15.0	7.2	4.7	0.0
Cycle Q Clear(g_c), s	15.8	0.0	0.0	11.6	0.0	13.7	5.1	0.0	15.0	22.3	4.7	0.0
Prop In Lane	0.20		0.02	1.00		0.23	1.00		0.35	1.00		0.00
Lane Grp Cap(c), veh/h	583	0	0	432	0	715	563	0	809	314	871	0
V/C Ratio(X)	0.55	0.00	0.00	0.32	0.00	0.65	0.02	0.00	0.65	0.35	0.26	0.00
Avail Cap(c_a), veh/h	583	0	0	432	0	715	563	0	809	314	871	0
HCM Platoon Ratio	1.00	1.00	1.00	1.00	1.00	1.00	1.00	1.00	1.00	1.00	1.00	1.00
Upstream Filter(I)	1.00	0.00	0.00	1.00	0.00	1.00	1.00	0.00	1.00	1.00	1.00	0.00
Uniform Delay (d), s/veh	14.5	0.0	0.0	14.9	0.0	15.5	12.0	0.0	13.2	21.7	10.4	0.0
Incr Delay (d2), s/veh	3.8	0.0	0.0	1.9	0.0	4.6	0.1	0.0	4.1	3.1	0.7	0.0
Initial Q Delay(d3),s/veh	0.0	0.0	0.0	0.0	0.0	0.0	0.0	0.0	0.0	0.0	0.0	0.0
%ile BackOfQ(50%),veh/ln	3.6	0.0	0.0	1.6	0.0	5.8	0.1	0.0	6.0	1.7	1.9	0.0
Unsig. Movement Delay, s/veh												
LnGrp Delay(d),s/veh	18.2	0.0	0.0	16.8	0.0	20.1	12.1	0.0	17.3	24.8	11.1	0.0
LnGrp LOS	B	A	A	B	A	C	B	A	B	C	B	A
Approach Vol, veh/h		323			602			541			334	
Approach Delay, s/veh		18.2			19.3			17.2			15.7	
Approach LOS		B			B			B			B	
Timer - Assigned Phs		2		4		6		8				
Phs Duration (G+Y+Rc), s		30.2		34.2		30.2		34.2				
Change Period (Y+Rc), s		* 4.2		* 4.2		* 4.2		* 4.2				
Max Green Setting (Gmax), s		* 26		* 30		* 26		* 30				
Max Q Clear Time (g_c+I1), s		17.8		17.0		15.7		24.3				
Green Ext Time (p_c), s		0.3		4.0		0.5		1.2				

Intersection Summary

HCM 6th Ctrl Delay	17.8
HCM 6th LOS	B

Notes

* HCM 6th computational engine requires equal clearance times for the phases crossing the barrier.

Intersection	
Intersection Delay, s/veh	23.2
Intersection LOS	C

Movement	EBL	EBT	EBR	WBL	WBT	WBR	NBL	NBT	NBR	SBL	SBT	SBR
Lane Configurations		↕			↕			↕			↕	
Traffic Vol, veh/h	64	377	25	34	293	24	15	74	33	11	92	35
Future Vol, veh/h	64	377	25	34	293	24	15	74	33	11	92	35
Peak Hour Factor	0.88	0.88	0.88	0.88	0.88	0.88	0.88	0.88	0.88	0.88	0.88	0.88
Heavy Vehicles, %	2	2	2	2	2	2	2	2	2	2	2	2
Mvmt Flow	73	428	28	39	333	27	17	84	38	13	105	40
Number of Lanes	0	1	0	0	1	0	0	1	0	0	1	0

Approach	EB	WB	NB	SB
Opposing Approach	WB	EB	SB	NB
Opposing Lanes	1	1	1	1
Conflicting Approach Left	SB	NB	EB	WB
Conflicting Lanes Left	1	1	1	1
Conflicting Approach Right	NB	SB	WB	EB
Conflicting Lanes Right	1	1	1	1
HCM Control Delay	31.9	19.4	12.4	12.8
HCM LOS	D	C	B	B

Lane	NBLn1	EBLn1	WBLn1	SBLn1
Vol Left, %	12%	14%	10%	8%
Vol Thru, %	61%	81%	83%	67%
Vol Right, %	27%	5%	7%	25%
Sign Control	Stop	Stop	Stop	Stop
Traffic Vol by Lane	122	466	351	138
LT Vol	15	64	34	11
Through Vol	74	377	293	92
RT Vol	33	25	24	35
Lane Flow Rate	139	530	399	157
Geometry Grp	1	1	1	1
Degree of Util (X)	0.265	0.843	0.652	0.297
Departure Headway (Hd)	6.872	5.729	5.881	6.81
Convergence, Y/N	Yes	Yes	Yes	Yes
Cap	521	635	614	525
Service Time	4.941	3.729	3.932	4.879
HCM Lane V/C Ratio	0.267	0.835	0.65	0.299
HCM Control Delay	12.4	31.9	19.4	12.8
HCM Lane LOS	B	D	C	B
HCM 95th-tile Q	1.1	9.2	4.8	1.2

Intersection												
Intersection Delay, s/veh	18.5											
Intersection LOS	C											

Movement	EBL	EBT	EBR	WBL	WBT	WBR	NBL	NBT	NBR	SBL	SBT	SBR
Lane Configurations		↕			↕			↕			↕	
Traffic Vol, veh/h	47	359	87	27	302	17	55	54	36	25	56	59
Future Vol, veh/h	47	359	87	27	302	17	55	54	36	25	56	59
Peak Hour Factor	0.97	0.97	0.97	0.97	0.97	0.97	0.97	0.97	0.97	0.97	0.97	0.97
Heavy Vehicles, %	2	2	2	2	2	2	2	2	2	2	2	2
Mvmt Flow	48	370	90	28	311	18	57	56	37	26	58	61
Number of Lanes	0	1	0	0	1	0	0	1	0	0	1	0

Approach	EB	WB	NB	SB
Opposing Approach	WB	EB	SB	NB
Opposing Lanes	1	1	1	1
Conflicting Approach Left	SB	NB	EB	WB
Conflicting Lanes Left	1	1	1	1
Conflicting Approach Right	NB	SB	WB	EB
Conflicting Lanes Right	1	1	1	1
HCM Control Delay	23.8	16.3	12.2	11.8
HCM LOS	C	C	B	B

Lane	NBLn1	EBLn1	WBLn1	SBLn1
Vol Left, %	38%	10%	8%	18%
Vol Thru, %	37%	73%	87%	40%
Vol Right, %	25%	18%	5%	42%
Sign Control	Stop	Stop	Stop	Stop
Traffic Vol by Lane	145	493	346	140
LT Vol	55	47	27	25
Through Vol	54	359	302	56
RT Vol	36	87	17	59
Lane Flow Rate	149	508	357	144
Geometry Grp	1	1	1	1
Degree of Util (X)	0.275	0.761	0.573	0.261
Departure Headway (Hd)	6.624	5.498	5.786	6.501
Convergence, Y/N	Yes	Yes	Yes	Yes
Cap	544	661	628	553
Service Time	4.652	3.498	3.786	4.53
HCM Lane V/C Ratio	0.274	0.769	0.568	0.26
HCM Control Delay	12.2	23.8	16.3	11.8
HCM Lane LOS	B	C	C	B
HCM 95th-tile Q	1.1	7	3.6	1

Intersection												
Int Delay, s/veh	1.4											
Movement	EBL	EBT	EBR	WBL	WBT	WBR	NBL	NBT	NBR	SBL	SBT	SBR
Lane Configurations		↕			↕	↕		↕			↕	
Traffic Vol, veh/h	14	464	50	5	404	7	23	0	24	5	0	16
Future Vol, veh/h	14	464	50	5	404	7	23	0	24	5	0	16
Conflicting Peds, #/hr	28	0	32	32	0	28	0	0	0	0	0	0
Sign Control	Free	Free	Free	Free	Free	Free	Stop	Stop	Stop	Stop	Stop	Stop
RT Channelized	-	-	None	-	-	None	-	-	None	-	-	None
Storage Length	-	-	-	-	-	75	-	-	-	-	-	-
Veh in Median Storage, #	-	0	-	-	0	-	-	0	-	-	0	-
Grade, %	-	0	-	-	0	-	-	0	-	-	0	-
Peak Hour Factor	94	94	94	94	94	94	94	94	94	94	94	94
Heavy Vehicles, %	2	2	2	2	2	2	2	2	2	2	2	2
Mvmt Flow	15	494	53	5	430	7	24	0	26	5	0	17

Major/Minor	Major1			Major2			Minor1			Minor2		
Conflicting Flow All	465	0	0	579	0	0	1035	1058	553	1032	1077	458
Stage 1	-	-	-	-	-	-	583	583	-	468	468	-
Stage 2	-	-	-	-	-	-	452	475	-	564	609	-
Critical Hdwy	4.12	-	-	4.12	-	-	7.12	6.52	6.22	7.12	6.52	6.22
Critical Hdwy Stg 1	-	-	-	-	-	-	6.12	5.52	-	6.12	5.52	-
Critical Hdwy Stg 2	-	-	-	-	-	-	6.12	5.52	-	6.12	5.52	-
Follow-up Hdwy	2.218	-	-	2.218	-	-	3.518	4.018	3.318	3.518	4.018	3.318
Pot Cap-1 Maneuver	1096	-	-	995	-	-	210	225	533	211	219	603
Stage 1	-	-	-	-	-	-	498	499	-	575	561	-
Stage 2	-	-	-	-	-	-	587	557	-	510	485	-
Platoon blocked, %		-	-		-	-						
Mov Cap-1 Maneuver	1067	-	-	965	-	-	194	207	517	191	201	587
Mov Cap-2 Maneuver	-	-	-	-	-	-	194	207	-	191	201	-
Stage 1	-	-	-	-	-	-	473	475	-	549	542	-
Stage 2	-	-	-	-	-	-	566	538	-	475	461	-

Approach	EB			WB			NB			SB		
HCM Control Delay, s	0.2			0.1			20.3			14.7		
HCM LOS							C			B		

Minor Lane/Major Mvmt	NBLn1	EBL	EBT	EBR	WBL	WBT	WBR	SBLn1
Capacity (veh/h)	285	1067	-	-	965	-	-	393
HCM Lane V/C Ratio	0.175	0.014	-	-	0.006	-	-	0.057
HCM Control Delay (s)	20.3	8.4	0	-	8.8	0	-	14.7
HCM Lane LOS	C	A	A	-	A	A	-	B
HCM 95th %tile Q(veh)	0.6	0	-	-	0	-	-	0.2

Intersection												
Int Delay, s/veh	1											
Movement	EBL	EBT	EBR	WBL	WBT	WBR	NBL	NBT	NBR	SBL	SBT	SBR
Lane Configurations		↗			↖			↔			↔	
Traffic Vol, veh/h	0	501	0	0	443	0	0	0	0	27	0	24
Future Vol, veh/h	0	501	0	0	443	0	0	0	0	27	0	24
Conflicting Peds, #/hr	0	0	27	27	0	0	0	0	0	0	0	0
Sign Control	Free	Free	Free	Free	Free	Free	Stop	Stop	Stop	Stop	Stop	Stop
RT Channelized	-	-	None	-	-	None	-	-	None	-	-	None
Storage Length	-	-	-	-	-	-	-	-	-	-	-	-
Veh in Median Storage, #	-	0	-	-	0	-	-	0	-	-	0	-
Grade, %	-	0	-	-	0	-	-	0	-	-	0	-
Peak Hour Factor	93	93	93	93	93	93	93	93	93	93	93	93
Heavy Vehicles, %	2	2	2	2	2	2	2	2	2	2	2	2
Mvmt Flow	0	539	0	0	476	0	0	0	0	29	0	26



















Major/Minor	Major1			Major2			Minor1			Minor2		
Conflicting Flow All	-	0	0	566	0	0	1055	1042	566	1015	1042	476
Stage 1	-	-	-	-	-	-	566	566	-	476	476	-
Stage 2	-	-	-	-	-	-	489	476	-	539	566	-
Critical Hdwy	-	-	-	4.12	-	-	7.12	6.52	6.22	7.12	6.52	6.22
Critical Hdwy Stg 1	-	-	-	-	-	-	6.12	5.52	-	6.12	5.52	-
Critical Hdwy Stg 2	-	-	-	-	-	-	6.12	5.52	-	6.12	5.52	-
Follow-up Hdwy	-	-	-	2.218	-	-	3.518	4.018	3.318	3.518	4.018	3.318
Pot Cap-1 Maneuver	0	-	-	1006	-	0	204	230	524	217	230	589
Stage 1	0	-	-	-	-	0	509	507	-	570	557	-
Stage 2	0	-	-	-	-	0	561	557	-	527	507	-
Platoon blocked, %	-	-	-	-	-	-	-	-	-	-	-	-
Mov Cap-1 Maneuver	-	-	-	980	-	-	190	224	511	217	224	589
Mov Cap-2 Maneuver	-	-	-	-	-	-	190	224	-	217	224	-
Stage 1	-	-	-	-	-	-	509	494	-	570	557	-
Stage 2	-	-	-	-	-	-	536	557	-	527	494	-

Approach	EB	WB	NB	SB
HCM Control Delay, s	0	0	0	19.1
HCM LOS			A	C

Minor Lane/Major Mvmt	NBLn1	EBT	EBR	WBL	WBT	SBLn1
Capacity (veh/h)	-	-	-	980	-	309
HCM Lane V/C Ratio	-	-	-	-	-	0.177
HCM Control Delay (s)	0	-	-	0	-	19.1
HCM Lane LOS	A	-	-	A	-	C
HCM 95th %tile Q(veh)	-	-	-	0	-	0.6

HCM 6th Signalized Intersection Summary
5: S B St & 9th Ave

Cumulative Plus Project PM
06/09/2023

												
Movement	EBL	EBT	EBR	WBL	WBT	WBR	NBL	NBT	NBR	SBL	SBT	SBR
Lane Configurations												
Traffic Volume (veh/h)	68	208	27	138	212	117	9	302	144	149	345	97
Future Volume (veh/h)	68	208	27	138	212	117	9	302	144	149	345	97
Initial Q (Qb), veh	0	0	0	0	0	0	0	0	0	0	0	0
Ped-Bike Adj(A_pbT)	0.97		0.93	0.97		0.93	0.99		0.95	0.99		0.95
Parking Bus, Adj	1.00	1.00	1.00	1.00	1.00	1.00	1.00	1.00	1.00	1.00	1.00	1.00
Work Zone On Approach		No			No			No			No	
Adj Sat Flow, veh/h/ln	1870	1870	1870	1870	1870	1870	1870	1870	1870	1870	1870	1870
Adj Flow Rate, veh/h	73	224	28	148	228	78	10	325	121	160	371	63
Peak Hour Factor	0.93	0.93	0.93	0.93	0.93	0.93	0.93	0.93	0.93	0.93	0.93	0.93
Percent Heavy Veh, %	2	2	2	2	2	2	2	2	2	2	2	2
Cap, veh/h	165	470	53	502	526	180	392	596	222	377	720	122
Arrive On Green	0.40	0.40	0.40	0.40	0.40	0.40	0.47	0.47	0.47	0.47	0.47	0.47
Sat Flow, veh/h	240	1164	132	1097	1303	446	944	1280	476	934	1546	262
Grp Volume(v), veh/h	325	0	0	148	0	306	10	0	446	160	0	434
Grp Sat Flow(s),veh/h/ln	1537	0	0	1097	0	1749	944	0	1756	934	0	1808
Q Serve(g_s), s	2.4	0.0	0.0	0.0	0.0	8.1	0.5	0.0	11.7	9.5	0.0	10.9
Cycle Q Clear(g_c), s	10.6	0.0	0.0	9.0	0.0	8.1	11.3	0.0	11.7	21.2	0.0	10.9
Prop In Lane	0.22		0.09	1.00		0.25	1.00		0.27	1.00		0.15
Lane Grp Cap(c), veh/h	689	0	0	502	0	706	392	0	818	377	0	842
V/C Ratio(X)	0.47	0.00	0.00	0.29	0.00	0.43	0.03	0.00	0.55	0.42	0.00	0.52
Avail Cap(c_a), veh/h	689	0	0	502	0	706	392	0	818	377	0	842
HCM Platoon Ratio	1.00	1.00	1.00	1.00	1.00	1.00	1.00	1.00	1.00	1.00	1.00	1.00
Upstream Filter(I)	1.00	0.00	0.00	1.00	0.00	1.00	1.00	0.00	1.00	1.00	0.00	1.00
Uniform Delay (d), s/veh	14.2	0.0	0.0	14.1	0.0	13.9	16.1	0.0	12.3	19.9	0.0	12.1
Incr Delay (d2), s/veh	2.3	0.0	0.0	1.5	0.0	1.9	0.1	0.0	2.6	3.5	0.0	2.2
Initial Q Delay(d3),s/veh	0.0	0.0	0.0	0.0	0.0	0.0	0.0	0.0	0.0	0.0	0.0	0.0
%ile BackOfQ(50%),veh/ln	3.5	0.0	0.0	1.6	0.0	3.3	0.1	0.0	4.6	2.3	0.0	4.3
Unsig. Movement Delay, s/veh												
LnGrp Delay(d),s/veh	16.5	0.0	0.0	15.6	0.0	15.8	16.2	0.0	14.9	23.4	0.0	14.3
LnGrp LOS	B	A	A	B	A	B	B	A	B	C	A	B
Approach Vol, veh/h		325			454			456			594	
Approach Delay, s/veh		16.5			15.8			14.9			16.8	
Approach LOS		B			B			B			B	
Timer - Assigned Phs		2		4		6		8				
Phs Duration (G+Y+Rc), s		30.2		34.2		30.2		34.2				
Change Period (Y+Rc), s		* 4.2		* 4.2		* 4.2		* 4.2				
Max Green Setting (Gmax), s		* 26		* 30		* 26		* 30				
Max Q Clear Time (g_c+I1), s		12.6		13.7		11.0		23.2				
Green Ext Time (p_c), s		0.4		3.7		0.4		2.6				

Intersection Summary

HCM 6th Ctrl Delay	16.0
HCM 6th LOS	B

Notes

* HCM 6th computational engine requires equal clearance times for the phases crossing the barrier.

Appendix B: Existing Traffic Counts



S Claremont St E 5th Ave



Peak Hour

Date: 11/16/2022
Count Period: 7:00 AM to 9:00 AM
Peak Hour: 7:45 AM to 8:45 AM

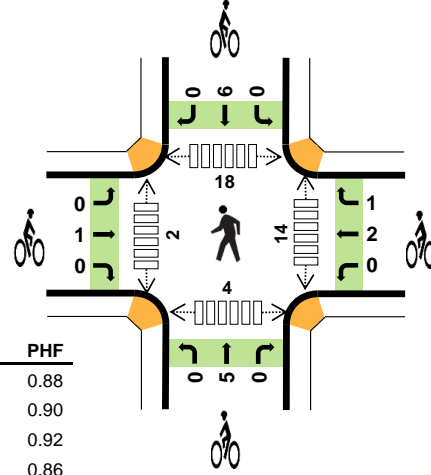
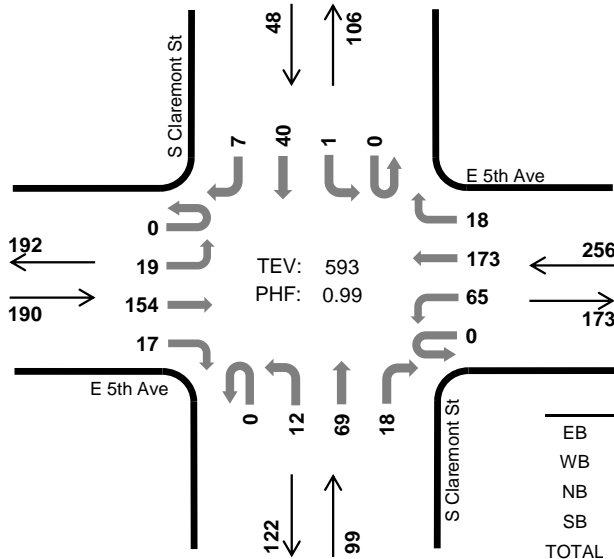

	HV %:	PHF
EB	1.1%	0.88
WB	3.9%	0.90
NB	4.0%	0.92
SB	4.2%	0.86
TOTAL	3.0%	0.99

Two-Hour Count Summaries

Interval Start	E 5th Ave Eastbound				E 5th Ave Westbound				S Claremont St Northbound				S Claremont St Southbound				15-min Total	Rolling One Hour	
	UT	LT	TH	RT	UT	LT	TH	RT	UT	LT	TH	RT	UT	LT	TH	RT			
7:00 AM	0	1	19	1	0	5	12	0	0	0	8	2	0	1	6	0	55	0	
7:15 AM	0	1	20	2	0	7	30	1	0	3	11	5	0	1	4	0	85	0	
7:30 AM	0	6	23	4	0	14	37	0	0	4	13	4	0	1	8	1	115	0	
7:45 AM	0	4	32	8	0	19	49	3	0	5	13	3	0	0	10	4	150	405	
8:00 AM	0	5	35	1	0	15	49	2	0	3	18	5	0	0	12	2	147	497	
8:15 AM	0	4	42	5	0	16	43	2	0	2	19	4	0	1	9	0	147	559	
8:30 AM	0	6	45	3	0	15	32	11	0	2	19	6	0	0	9	1	149	593	
8:45 AM	0	2	24	5	0	23	40	6	0	3	13	14	0	0	7	0	137	580	
Count Total	0	29	240	29	0	114	292	25	0	22	114	43	0	4	65	8	985	0	
Peak Hour	All	0	19	154	17	0	65	173	18	0	12	69	18	0	1	40	7	593	0
	HV	0	0	1	1	0	3	7	0	0	1	3	0	0	0	2	0	18	0
	HV%	-	0%	1%	6%	-	5%	4%	0%	-	8%	4%	0%	-	0%	5%	0%	3%	0

Note: Two-hour count summary volumes include heavy vehicles but exclude bicycles in overall count.

Interval Start	Heavy Vehicle Totals					Bicycles					Pedestrians (Crossing Leg)				
	EB	WB	NB	SB	Total	EB	WB	NB	SB	Total	East	West	North	South	Total
7:00 AM	2	2	0	2	6	0	0	0	0	0	0	0	0	0	0
7:15 AM	0	3	2	0	5	0	1	1	0	2	1	1	1	1	4
7:30 AM	0	6	2	0	8	1	2	1	0	4	0	1	6	1	8
7:45 AM	2	1	1	1	5	0	0	0	2	2	2	0	6	1	9
8:00 AM	0	3	2	0	5	0	1	0	1	2	7	0	6	1	14
8:15 AM	0	4	0	0	4	1	1	1	2	5	2	2	3	0	7
8:30 AM	0	2	1	1	4	0	1	4	1	6	3	0	3	2	8
8:45 AM	1	0	0	0	1	3	1	1	0	5	8	1	7	1	17
Count Total	5	21	8	4	38	5	7	8	6	26	23	5	32	7	67
Peak Hour	2	10	4	2	18	1	3	5	6	15	14	2	18	4	38

Two-Hour Count Summaries - Heavy Vehicles																		
Interval Start	E 5th Ave				E 5th Ave				S Claremont St				S Claremont St				15-min Total	Rolling One Hour
	Eastbound				Westbound				Northbound				Southbound					
	UT	LT	TH	RT	UT	LT	TH	RT	UT	LT	TH	RT	UT	LT	TH	RT		
7:00 AM	0	0	2	0	0	1	1	0	0	0	0	0	0	0	2	0	6	0
7:15 AM	0	0	0	0	0	1	2	0	0	0	2	0	0	0	0	0	5	0
7:30 AM	0	0	0	0	0	3	3	0	0	1	1	0	0	0	0	0	8	0
7:45 AM	0	0	1	1	0	0	1	0	0	1	0	0	0	0	1	0	5	24
8:00 AM	0	0	0	0	0	1	2	0	0	0	2	0	0	0	0	0	5	23
8:15 AM	0	0	0	0	0	2	2	0	0	0	0	0	0	0	0	0	4	22
8:30 AM	0	0	0	0	0	0	2	0	0	0	1	0	0	0	1	0	4	18
8:45 AM	0	0	1	0	0	0	0	0	0	0	0	0	0	0	0	0	1	14
Count Total	0	0	4	1	0	8	13	0	0	2	6	0	0	0	4	0	38	0
Peak Hour	0	0	1	1	0	3	7	0	0	1	3	0	0	0	2	0	18	0

Two-Hour Count Summaries - Bikes																	
Interval Start	E 5th Ave			E 5th Ave			S Claremont St			S Claremont St			15-min Total	Rolling One Hour			
	Eastbound			Westbound			Northbound			Southbound							
	LT	TH	RT	LT	TH	RT	LT	TH	RT	LT	TH	RT					
7:00 AM	0	0	0	0	0	0	0	0	0	0	0	0	0	0	0	0	0
7:15 AM	0	0	0	0	1	0	0	1	0	0	0	0	0	0	0	2	0
7:30 AM	0	1	0	0	2	0	0	1	0	0	0	0	0	0	0	4	0
7:45 AM	0	0	0	0	0	0	0	0	0	0	0	0	0	2	0	2	8
8:00 AM	0	0	0	0	1	0	0	0	0	0	1	0	0	1	0	2	10
8:15 AM	0	1	0	0	1	0	0	1	0	0	2	0	0	2	0	5	13
8:30 AM	0	0	0	0	0	1	0	4	0	0	1	0	0	1	0	6	15
8:45 AM	0	1	2	0	1	0	0	1	0	0	0	0	0	0	0	5	18
Count Total	0	3	2	0	6	1	0	8	0	0	6	0	0	6	0	26	0
Peak Hour	0	1	0	0	2	1	0	5	0	0	6	0	0	6	0	15	0

Note: U-Turn volumes for bikes are included in Left-Turn, if any.

S Claremont St E 5th Ave



Peak Hour

Date: 11/16/2022
Count Period: 4:00 PM to 6:00 PM
Peak Hour: 4:45 PM to 5:45 PM

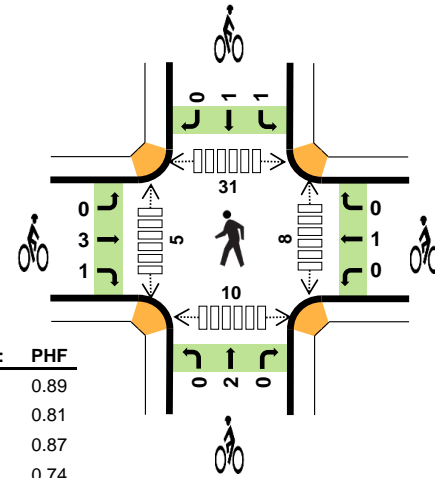
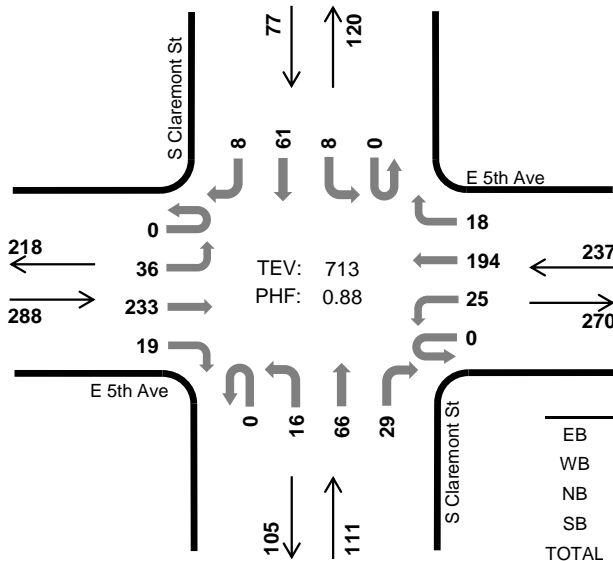

	HV %:	PHF
EB	0.7%	0.89
WB	0.8%	0.81
NB	2.7%	0.87
SB	2.6%	0.74
TOTAL	1.3%	0.88

Two-Hour Count Summaries

Interval Start	E 5th Ave Eastbound				E 5th Ave Westbound				S Claremont St Northbound				S Claremont St Southbound				15-min Total	Rolling One Hour	
	UT	LT	TH	RT	UT	LT	TH	RT	UT	LT	TH	RT	UT	LT	TH	RT			
4:00 PM	0	3	42	2	0	11	41	2	1	3	14	8	0	0	13	1	141	0	
4:15 PM	0	10	55	6	0	16	37	0	0	8	20	6	0	1	15	2	176	0	
4:30 PM	0	2	55	3	0	6	40	0	0	1	16	8	0	1	14	2	148	0	
4:45 PM	0	7	58	7	0	6	48	1	0	6	13	5	0	2	17	2	172	637	
5:00 PM	0	12	65	4	0	12	53	8	0	3	19	9	0	2	13	2	202	698	
5:15 PM	0	7	55	1	0	3	49	7	0	4	19	9	0	2	22	2	180	702	
5:30 PM	0	10	55	7	0	4	44	2	0	3	15	6	0	2	9	2	159	713	
5:45 PM	0	7	37	4	0	9	49	5	0	2	18	7	0	3	5	1	147	688	
Count Total	0	58	422	34	0	67	361	25	1	30	134	58	0	13	108	14	1,325	0	
Peak Hour	All	0	36	233	19	0	25	194	18	0	16	66	29	0	8	61	8	713	0
	HV	0	0	2	0	0	0	2	0	0	1	1	1	0	0	1	1	9	0
	HV%	-	0%	1%	0%	-	0%	1%	0%	-	6%	2%	3%	-	0%	2%	13%	1%	0

Note: Two-hour count summary volumes include heavy vehicles but exclude bicycles in overall count.

Interval Start	Heavy Vehicle Totals					Bicycles					Pedestrians (Crossing Leg)				
	EB	WB	NB	SB	Total	EB	WB	NB	SB	Total	East	West	North	South	Total
4:00 PM	1	2	0	1	4	0	0	1	0	1	1	1	6	0	8
4:15 PM	1	3	0	0	4	0	2	2	0	4	2	0	3	1	6
4:30 PM	0	0	0	0	0	3	0	1	3	7	1	0	2	2	5
4:45 PM	1	0	0	1	2	1	0	0	0	1	2	0	9	3	14
5:00 PM	0	1	2	1	4	1	0	1	0	2	3	0	7	0	10
5:15 PM	1	1	1	0	3	1	1	1	2	5	1	5	11	0	17
5:30 PM	0	0	0	0	0	1	0	0	0	1	2	0	4	7	13
5:45 PM	1	0	0	0	1	0	0	0	0	0	2	0	11	3	16
Count Total	5	7	3	3	18	7	3	6	5	21	14	6	53	16	89
Peak Hour	2	2	3	2	9	4	1	2	2	9	8	5	31	10	54

Two-Hour Count Summaries - Heavy Vehicles																		
Interval Start	E 5th Ave				E 5th Ave				S Claremont St				S Claremont St				15-min Total	Rolling One Hour
	Eastbound				Westbound				Northbound				Southbound					
	UT	LT	TH	RT	UT	LT	TH	RT	UT	LT	TH	RT	UT	LT	TH	RT		
4:00 PM	0	0	1	0	0	0	2	0	0	0	0	0	0	0	1	0	4	0
4:15 PM	0	0	1	0	0	1	2	0	0	0	0	0	0	0	0	0	4	0
4:30 PM	0	0	0	0	0	0	0	0	0	0	0	0	0	0	0	0	0	0
4:45 PM	0	0	1	0	0	0	0	0	0	0	0	0	0	0	0	1	2	10
5:00 PM	0	0	0	0	0	0	1	0	0	1	1	0	0	0	1	0	4	10
5:15 PM	0	0	1	0	0	0	1	0	0	0	0	1	0	0	0	0	3	9
5:30 PM	0	0	0	0	0	0	0	0	0	0	0	0	0	0	0	0	0	9
5:45 PM	0	0	0	1	0	0	0	0	0	0	0	0	0	0	0	0	1	8
Count Total	0	0	4	1	0	1	6	0	0	1	1	1	0	0	2	1	18	0
Peak Hour	0	0	2	0	0	0	2	0	0	1	1	1	0	0	1	1	9	0
Two-Hour Count Summaries - Bikes																		
Interval Start	E 5th Ave			E 5th Ave			S Claremont St			S Claremont St			15-min Total	Rolling One Hour				
	Eastbound			Westbound			Northbound			Southbound								
	LT	TH	RT	LT	TH	RT	LT	TH	RT	LT	TH	RT						
4:00 PM	0	0	0	0	0	0	0	1	0	0	0	0	0	0	1	0		
4:15 PM	0	0	0	0	2	0	0	2	0	0	0	0	0	0	4	0		
4:30 PM	0	3	0	0	0	0	0	0	0	1	0	0	3	0	7	0		
4:45 PM	0	1	0	0	0	0	0	0	0	0	0	0	0	0	1	13		
5:00 PM	0	1	0	0	0	0	0	0	1	0	0	0	0	0	2	14		
5:15 PM	0	1	0	0	1	0	0	1	0	0	1	1	1	0	5	15		
5:30 PM	0	0	1	0	0	0	0	0	0	0	0	0	0	0	1	9		
5:45 PM	0	0	0	0	0	0	0	0	0	0	0	0	0	0	0	8		
Count Total	0	6	1	0	3	0	0	5	1	0	1	4	0	21	0			
Peak Hour	0	3	1	0	1	0	0	2	0	0	1	1	0	9	0			
<i>Note: U-Turn volumes for bikes are included in Left-Turn, if any.</i>																		

S Claremont St 9th Ave



Peak Hour

Date: 11/16/2022
Count Period: 7:00 AM to 9:00 AM
Peak Hour: 7:45 AM to 8:45 AM

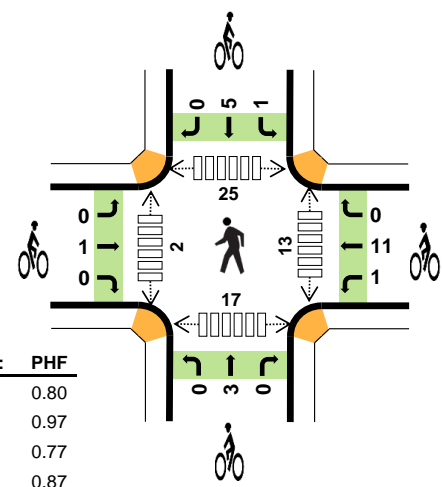
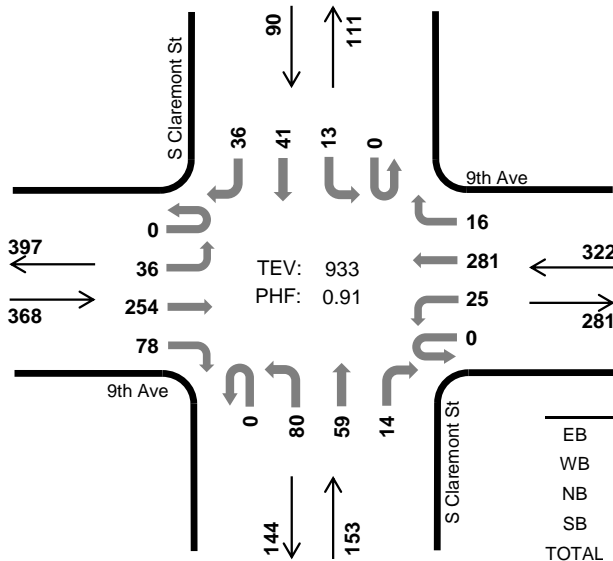

	HV %:	PHF
EB	1.9%	0.80
WB	2.2%	0.97
NB	2.6%	0.77
SB	2.2%	0.87
TOTAL	2.1%	0.91

Two-Hour Count Summaries

Interval Start	9th Ave Eastbound				9th Ave Westbound				S Claremont St Northbound				S Claremont St Southbound				15-min Total	Rolling One Hour	
	UT	LT	TH	RT	UT	LT	TH	RT	UT	LT	TH	RT	UT	LT	TH	RT			
7:00 AM	0	5	34	6	0	4	22	3	0	10	7	4	1	2	4	5	107	0	
7:15 AM	0	8	30	3	0	5	32	4	0	8	7	3	0	0	4	3	107	0	
7:30 AM	0	8	39	15	0	6	44	1	0	9	12	5	0	2	8	9	158	0	
7:45 AM	0	4	43	12	0	5	67	6	0	17	15	3	0	3	11	10	196	568	
8:00 AM	0	10	58	28	0	7	71	1	0	31	15	4	0	3	9	14	251	712	
8:15 AM	0	13	84	18	0	7	73	2	0	16	14	6	0	5	11	7	256	861	
8:30 AM	0	9	69	20	0	6	70	7	0	16	15	1	0	2	10	5	230	933	
8:45 AM	0	8	60	12	0	3	45	4	0	12	22	3	0	4	7	10	190	927	
Count Total	0	65	417	114	0	43	424	28	0	119	107	29	1	21	64	63	1,495	0	
Peak Hour	All	0	36	254	78	0	25	281	16	0	80	59	14	0	13	41	36	933	0
	HV	0	0	6	1	0	0	6	1	0	2	0	2	0	0	1	1	20	0
	HV%	-	0%	2%	1%	-	0%	2%	6%	-	3%	0%	14%	-	0%	2%	3%	2%	0

Note: Two-hour count summary volumes include heavy vehicles but exclude bicycles in overall count.

Interval Start	Heavy Vehicle Totals					Bicycles					Pedestrians (Crossing Leg)				
	EB	WB	NB	SB	Total	EB	WB	NB	SB	Total	East	West	North	South	Total
7:00 AM	0	0	2	0	2	1	1	0	0	2	0	1	2	4	7
7:15 AM	1	0	3	0	4	1	2	0	0	3	4	2	5	5	16
7:30 AM	4	1	2	2	9	0	1	0	0	1	0	1	4	5	10
7:45 AM	2	3	2	0	7	0	4	0	3	7	3	2	5	4	14
8:00 AM	0	1	0	0	1	0	5	0	1	6	5	0	5	4	14
8:15 AM	1	1	1	1	4	0	2	0	2	4	0	0	9	4	13
8:30 AM	4	2	1	1	8	1	1	3	0	5	5	0	6	5	16
8:45 AM	2	1	1	0	4	1	1	0	3	5	0	2	3	6	11
Count Total	14	9	12	4	39	4	17	3	9	33	17	8	39	37	101
Peak Hour	7	7	4	2	20	1	12	3	6	22	13	2	25	17	57

Two-Hour Count Summaries - Heavy Vehicles																		
Interval Start	9th Ave				9th Ave				S Claremont St				S Claremont St				15-min Total	Rolling One Hour
	Eastbound				Westbound				Northbound				Southbound					
	UT	LT	TH	RT	UT	LT	TH	RT	UT	LT	TH	RT	UT	LT	TH	RT		
7:00 AM	0	0	0	0	0	0	0	0	0	1	1	0	0	0	0	0	2	0
7:15 AM	0	0	1	0	0	0	0	0	0	0	2	1	0	0	0	0	4	0
7:30 AM	0	0	3	1	0	1	0	0	0	0	1	0	1	0	0	0	9	0
7:45 AM	0	0	2	0	0	0	2	1	0	1	0	0	1	0	0	0	7	22
8:00 AM	0	0	0	0	0	0	1	0	0	0	0	0	0	0	0	0	1	21
8:15 AM	0	0	1	0	0	0	1	0	0	1	0	0	0	0	0	1	4	21
8:30 AM	0	0	3	1	0	0	2	0	0	0	0	1	0	0	0	1	8	20
8:45 AM	0	0	2	0	0	0	1	0	0	0	1	0	0	0	0	0	4	17
Count Total	0	0	12	2	0	1	7	1	0	6	3	3	0	0	1	3	39	0
Peak Hour	0	0	6	1	0	0	6	1	0	2	0	2	0	0	1	1	20	0
Two-Hour Count Summaries - Bikes																		
Interval Start	9th Ave			9th Ave			S Claremont St			S Claremont St			15-min Total	Rolling One Hour				
	Eastbound			Westbound			Northbound			Southbound								
	LT	TH	RT	LT	TH	RT	LT	TH	RT	LT	TH	RT						
7:00 AM	0	1	0	0	1	0	0	0	0	0	0	0	0	0	0	2	0	
7:15 AM	0	1	0	0	1	1	0	0	0	0	0	0	0	0	0	3	0	
7:30 AM	0	0	0	0	0	1	0	0	0	0	0	0	0	0	0	1	0	
7:45 AM	0	0	0	0	4	0	0	0	0	0	0	0	3	0	0	7	13	
8:00 AM	0	0	0	0	5	0	0	0	0	0	0	0	1	0	0	6	17	
8:15 AM	0	0	0	1	1	0	0	0	0	0	0	1	1	0	0	4	18	
8:30 AM	0	1	0	0	1	0	0	3	0	0	0	0	0	0	0	5	22	
8:45 AM	0	1	0	0	1	0	0	0	0	0	0	1	2	0	0	5	20	
Count Total	0	4	0	1	14	2	0	3	0	0	2	7	0	0	0	33	0	
Peak Hour	0	1	0	1	11	0	0	3	0	0	1	5	0	0	0	22	0	
<i>Note: U-Turn volumes for bikes are included in Left-Turn, if any.</i>																		

S Claremont St 9th Ave



Peak Hour

Date: 11/16/2022
Count Period: 4:00 PM to 6:00 PM
Peak Hour: 4:15 PM to 5:15 PM

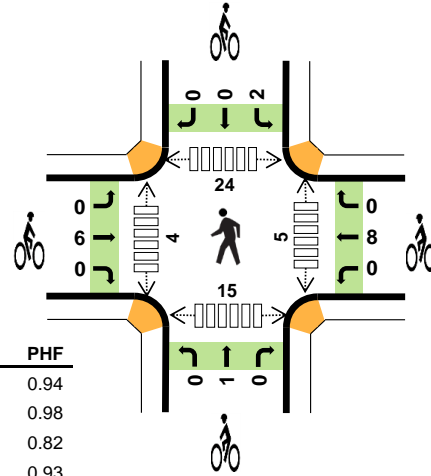
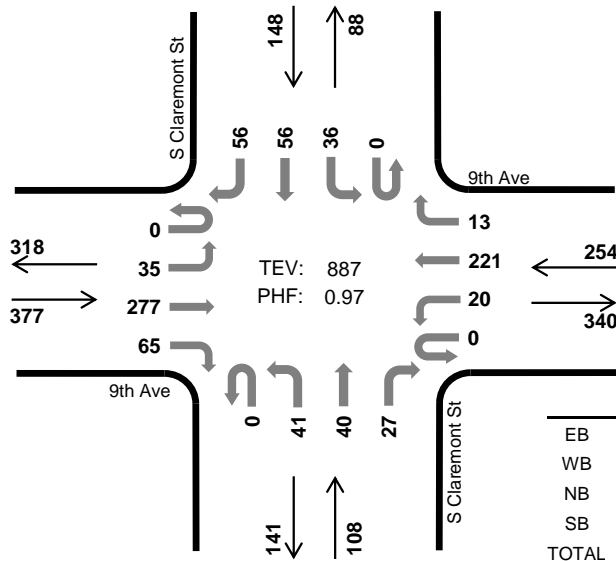

	HV %:	PHF
EB	1.9%	0.94
WB	2.8%	0.98
NB	2.8%	0.82
SB	2.0%	0.93
TOTAL	2.3%	0.97

Two-Hour Count Summaries

Interval Start	9th Ave Eastbound				9th Ave Westbound				S Claremont St Northbound				S Claremont St Southbound				15-min Total	Rolling One Hour	
	UT	LT	TH	RT	UT	LT	TH	RT	UT	LT	TH	RT	UT	LT	TH	RT			
4:00 PM	0	8	56	21	0	8	47	7	0	9	11	6	0	10	15	10	208	0	
4:15 PM	0	10	66	20	0	9	51	5	0	8	13	7	0	11	14	15	229	0	
4:30 PM	0	10	74	16	0	5	56	2	0	10	9	5	0	10	12	16	225	0	
4:45 PM	0	9	63	14	0	2	56	4	0	7	10	6	0	5	17	13	206	868	
5:00 PM	0	6	74	15	0	4	58	2	0	16	8	9	0	10	13	12	227	887	
5:15 PM	1	6	75	13	0	8	52	3	0	10	15	4	0	7	22	13	229	887	
5:30 PM	0	4	83	12	1	4	48	2	0	12	11	1	0	4	11	5	198	860	
5:45 PM	0	10	61	9	0	6	45	3	0	8	9	8	0	3	13	6	181	835	
Count Total	1	63	552	120	1	46	413	28	0	80	86	46	0	60	117	90	1,703	0	
Peak Hour	All	0	35	277	65	0	20	221	13	0	41	40	27	0	36	56	56	887	0
	HV	0	1	5	1	0	4	1	2	0	0	0	3	0	1	2	0	20	0
	HV%	-	3%	2%	2%	-	20%	0%	15%	-	0%	0%	11%	-	3%	4%	0%	2%	0

Note: Two-hour count summary volumes include heavy vehicles but exclude bicycles in overall count.

Interval Start	Heavy Vehicle Totals					Bicycles					Pedestrians (Crossing Leg)				
	EB	WB	NB	SB	Total	EB	WB	NB	SB	Total	East	West	North	South	Total
4:00 PM	5	0	0	0	5	2	3	2	0	7	3	2	6	2	13
4:15 PM	1	2	2	0	5	1	4	1	0	6	2	0	9	1	12
4:30 PM	2	4	0	0	6	1	1	0	0	2	0	0	6	5	11
4:45 PM	0	1	0	2	3	3	2	0	2	7	0	2	4	2	8
5:00 PM	4	0	1	1	6	1	1	0	0	2	3	2	5	7	17
5:15 PM	0	1	0	0	1	1	1	1	1	4	2	1	4	4	11
5:30 PM	2	0	0	0	2	0	0	1	0	1	0	0	6	0	6
5:45 PM	1	0	0	1	2	0	2	0	1	3	0	0	4	2	6
Count Total	15	8	3	4	30	9	14	5	4	32	10	7	44	23	84
Peak Hour	7	7	3	3	20	6	8	1	2	17	5	4	24	15	48

Two-Hour Count Summaries - Heavy Vehicles																		
Interval Start	9th Ave				9th Ave				S Claremont St				S Claremont St				15-min Total	Rolling One Hour
	Eastbound				Westbound				Northbound				Southbound					
	UT	LT	TH	RT	UT	LT	TH	RT	UT	LT	TH	RT	UT	LT	TH	RT		
4:00 PM	0	0	4	1	0	0	0	0	0	0	0	0	0	0	0	0	5	0
4:15 PM	0	0	0	1	0	1	0	1	0	0	0	2	0	0	0	0	5	0
4:30 PM	0	0	2	0	0	3	1	0	0	0	0	0	0	0	0	0	6	0
4:45 PM	0	0	0	0	0	0	0	1	0	0	0	0	0	0	1	1	3	19
5:00 PM	0	1	3	0	0	0	0	0	0	0	0	1	0	0	1	0	6	20
5:15 PM	0	0	0	0	0	0	1	0	0	0	0	0	0	0	0	0	1	16
5:30 PM	0	0	1	1	0	0	0	0	0	0	0	0	0	0	0	0	2	12
5:45 PM	0	0	1	0	0	0	0	0	0	0	0	0	0	0	1	0	2	11
Count Total	0	1	11	3	0	4	2	2	0	0	0	3	0	1	3	0	30	0
Peak Hour	0	1	5	1	0	4	1	2	0	0	0	3	0	1	2	0	20	0

Two-Hour Count Summaries - Bikes																
Interval Start	9th Ave			9th Ave			S Claremont St			S Claremont St			15-min Total	Rolling One Hour		
	Eastbound			Westbound			Northbound			Southbound						
	LT	TH	RT	LT	TH	RT	LT	TH	RT	LT	TH	RT				
4:00 PM	0	2	0	0	2	1	0	1	1	0	0	0	7	0		
4:15 PM	0	1	0	0	4	0	0	1	0	0	0	0	6	0		
4:30 PM	0	1	0	0	1	0	0	0	0	0	0	0	2	0		
4:45 PM	0	3	0	0	2	0	0	0	0	2	0	0	7	22		
5:00 PM	0	1	0	0	1	0	0	0	0	0	0	0	2	17		
5:15 PM	0	1	0	0	1	0	0	1	0	0	0	1	4	15		
5:30 PM	0	0	0	0	0	0	1	0	0	0	0	0	1	14		
5:45 PM	0	0	0	0	2	0	0	0	0	0	1	0	3	10		
Count Total	0	9	0	0	13	1	1	3	1	2	1	1	32	0		
Peak Hour	0	6	0	0	8	0	0	1	0	2	0	0	17	0		

Note: U-Turn volumes for bikes are included in Left-Turn, if any.

S Railroad Ave E 9th Ave



Peak Hour

Date: 11/16/2022
Count Period: 7:00 AM to 9:00 AM
Peak Hour: 7:45 AM to 8:45 AM

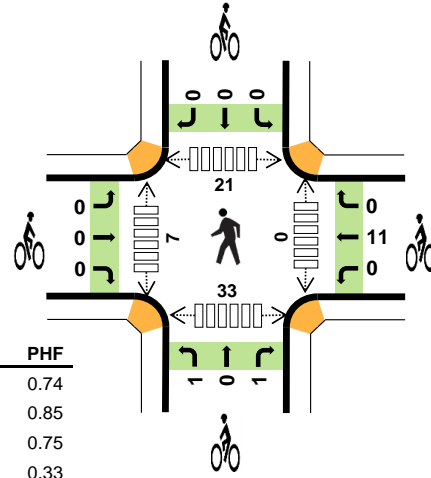
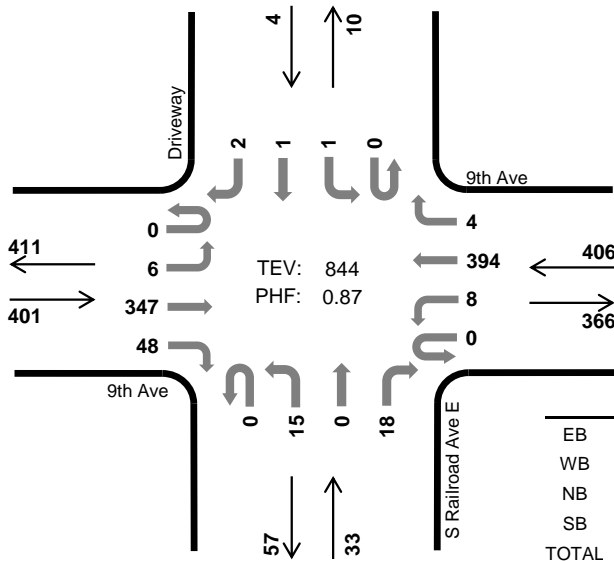

	HV %:	PHF
EB	1.7%	0.74
WB	2.5%	0.85
NB	0.0%	0.75
SB	0.0%	0.33
TOTAL	2.0%	0.87

Two-Hour Count Summaries

Interval Start	9th Ave Eastbound				9th Ave Westbound				S Railroad Ave E Northbound				Driveway Southbound				15-min Total	Rolling One Hour	
	UT	LT	TH	RT	UT	LT	TH	RT	UT	LT	TH	RT	UT	LT	TH	RT			
7:00 AM	0	0	38	2	0	2	34	0	2	0	0	5	0	0	0	0	83	0	
7:15 AM	0	0	35	4	0	3	41	0	0	4	0	3	0	0	0	0	90	0	
7:30 AM	0	1	65	1	0	2	57	0	1	4	0	0	0	0	0	0	131	0	
7:45 AM	0	1	60	9	0	4	91	0	0	5	0	3	0	0	0	0	173	477	
8:00 AM	0	2	83	11	0	1	118	0	0	2	0	4	0	0	1	0	222	616	
8:15 AM	0	3	112	20	0	2	96	1	0	4	0	4	0	0	0	0	242	768	
8:30 AM	0	0	92	8	0	1	89	3	0	4	0	7	0	1	0	2	207	844	
8:45 AM	0	4	71	7	0	3	63	3	0	4	1	7	0	1	0	0	164	835	
Count Total	0	11	556	62	0	18	589	7	3	27	1	33	0	2	1	2	1,312	0	
Peak Hour	All	0	6	347	48	0	8	394	4	0	15	0	18	0	1	1	2	844	0
	HV	0	0	7	0	0	1	9	0	0	0	0	0	0	0	0	0	17	0
	HV%	-	0%	2%	0%	-	13%	2%	0%	-	0%	-	0%	-	0%	0%	0%	2%	0

Note: Two-hour count summary volumes include heavy vehicles but exclude bicycles in overall count.

Interval Start	Heavy Vehicle Totals					Bicycles					Pedestrians (Crossing Leg)				
	EB	WB	NB	SB	Total	EB	WB	NB	SB	Total	East	West	North	South	Total
7:00 AM	0	1	0	0	1	1	1	0	0	2	0	1	2	2	5
7:15 AM	2	2	3	0	7	1	0	0	0	1	0	1	5	3	9
7:30 AM	4	3	0	0	7	0	1	0	0	1	0	1	5	4	10
7:45 AM	2	3	0	0	5	0	5	1	0	6	0	0	5	10	15
8:00 AM	0	1	0	0	1	0	6	0	0	6	0	3	3	12	18
8:15 AM	1	2	0	0	3	0	0	0	0	0	0	2	5	4	11
8:30 AM	4	4	0	0	8	0	0	1	0	1	0	2	8	7	17
8:45 AM	2	0	0	0	2	1	1	1	0	3	0	1	4	2	7
Count Total	15	16	3	0	34	3	14	3	0	20	0	11	37	44	92
Peak Hour	7	10	0	0	17	0	11	2	0	13	0	7	21	33	61

Two-Hour Count Summaries - Heavy Vehicles																		
Interval Start	9th Ave				9th Ave				S Railroad Ave E				Driveway				15-min Total	Rolling One Hour
	Eastbound				Westbound				Northbound				Southbound					
	UT	LT	TH	RT	UT	LT	TH	RT	UT	LT	TH	RT	UT	LT	TH	RT		
7:00 AM	0	0	0	0	0	1	0	0	0	0	0	0	0	0	0	0	1	0
7:15 AM	0	0	1	1	0	0	2	0	0	3	0	0	0	0	0	0	7	0
7:30 AM	0	0	4	0	0	0	3	0	0	0	0	0	0	0	0	0	7	0
7:45 AM	0	0	2	0	0	1	2	0	0	0	0	0	0	0	0	0	5	20
8:00 AM	0	0	0	0	0	0	1	0	0	0	0	0	0	0	0	0	1	20
8:15 AM	0	0	1	0	0	0	2	0	0	0	0	0	0	0	0	0	3	16
8:30 AM	0	0	4	0	0	0	4	0	0	0	0	0	0	0	0	0	8	17
8:45 AM	0	0	2	0	0	0	0	0	0	0	0	0	0	0	0	0	2	14
Count Total	0	0	14	1	0	2	14	0	0	3	0	0	0	0	0	0	34	0
Peak Hour	0	0	7	0	0	1	9	0	0	0	0	0	0	0	0	0	17	0
Two-Hour Count Summaries - Bikes																		
Interval Start	9th Ave			9th Ave			S Railroad Ave E			Driveway			15-min Total	Rolling One Hour				
	Eastbound			Westbound			Northbound			Southbound								
	LT	TH	RT	LT	TH	RT	LT	TH	RT	LT	TH	RT						
7:00 AM	0	1	0	0	1	0	0	0	0	0	0	0	0	0	2	0		
7:15 AM	0	1	0	0	0	0	0	0	0	0	0	0	0	0	1	0		
7:30 AM	0	0	0	0	1	0	0	0	0	0	0	0	0	0	1	0		
7:45 AM	0	0	0	0	5	0	1	0	0	0	0	0	0	0	6	10		
8:00 AM	0	0	0	0	6	0	0	0	0	0	0	0	0	0	6	14		
8:15 AM	0	0	0	0	0	0	0	0	0	0	0	0	0	0	0	13		
8:30 AM	0	0	0	0	0	0	0	0	1	0	0	0	0	0	1	13		
8:45 AM	0	1	0	0	1	0	1	0	0	0	0	0	0	0	3	10		
Count Total	0	3	0	0	14	0	2	0	1	0	0	0	0	0	20	0		
Peak Hour	0	0	0	0	11	0	1	0	1	0	0	0	0	0	13	0		
<i>Note: U-Turn volumes for bikes are included in Left-Turn, if any.</i>																		

S Railroad Ave E 9th Ave



Peak Hour

Date: 11/16/2022
Count Period: 4:00 PM to 6:00 PM
Peak Hour: 4:30 PM to 5:30 PM

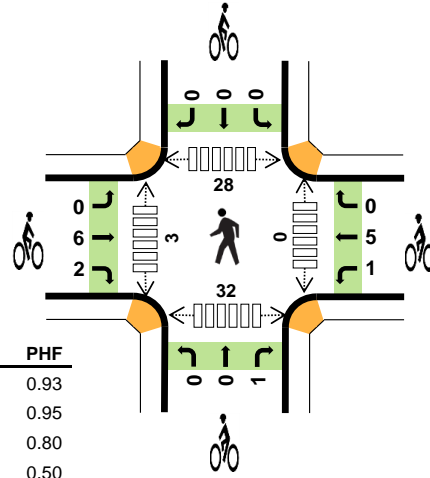
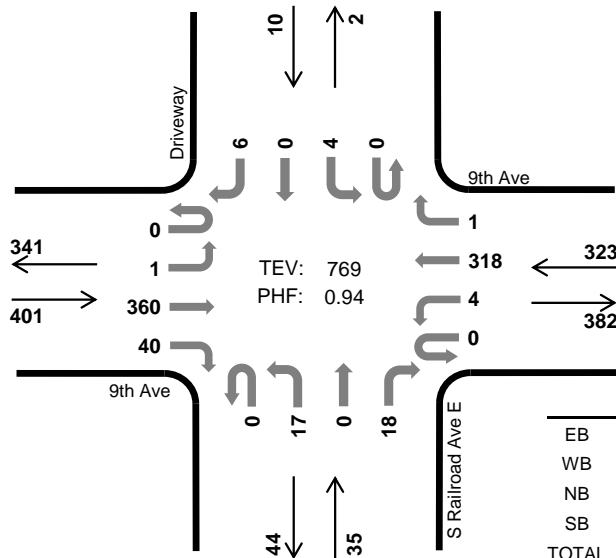

	HV %:	PHF
EB	1.7%	0.93
WB	0.6%	0.95
NB	2.9%	0.80
SB	0.0%	0.50
TOTAL	1.3%	0.94

Two-Hour Count Summaries

Interval Start	9th Ave Eastbound				9th Ave Westbound				S Railroad Ave E Northbound				S Railroad Ave E Southbound				15-min Total	Rolling One Hour	
	UT	LT	TH	RT	UT	LT	TH	RT	UT	LT	TH	RT	UT	LT	TH	RT			
4:00 PM	1	0	77	4	0	2	66	0	0	4	0	8	0	0	1	1	164	0	
4:15 PM	0	0	89	10	0	2	72	0	0	4	0	5	0	0	0	1	183	0	
4:30 PM	0	1	95	12	0	3	81	0	0	7	0	3	0	1	0	1	204	0	
4:45 PM	0	0	81	9	0	1	76	0	0	5	0	6	0	1	0	1	180	731	
5:00 PM	0	0	92	10	0	0	84	1	0	3	0	2	0	0	0	1	193	760	
5:15 PM	0	0	92	9	0	0	77	0	0	2	0	7	0	2	0	3	192	769	
5:30 PM	1	1	101	10	0	0	64	0	0	2	0	2	0	0	0	1	182	747	
5:45 PM	0	1	78	4	0	0	61	0	0	10	0	2	0	0	0	0	156	723	
Count Total	2	3	705	68	0	8	581	1	0	37	0	35	0	4	1	9	1,454	0	
Peak Hour	All	0	1	360	40	0	4	318	1	0	17	0	18	0	4	0	6	769	0
	HV	0	0	6	1	0	0	2	0	0	1	0	0	0	0	0	0	10	0
	HV%	-	0%	2%	3%	-	0%	1%	0%	-	6%	-	0%	-	0%	-	0%	1%	0

Note: Two-hour count summary volumes include heavy vehicles but exclude bicycles in overall count.

Interval Start	Heavy Vehicle Totals					Bicycles					Pedestrians (Crossing Leg)				
	EB	WB	NB	SB	Total	EB	WB	NB	SB	Total	East	West	North	South	Total
4:00 PM	6	0	0	0	6	1	3	1	0	5	0	2	6	5	13
4:15 PM	0	0	0	0	0	1	4	0	0	5	0	2	12	2	16
4:30 PM	3	1	1	0	5	3	0	0	0	3	0	2	10	10	22
4:45 PM	0	0	0	0	0	3	2	0	0	5	0	1	4	5	10
5:00 PM	4	0	0	0	4	1	1	1	0	3	0	0	5	6	11
5:15 PM	0	1	0	0	1	1	3	0	0	4	0	0	9	11	20
5:30 PM	2	0	0	0	2	1	1	0	0	2	0	0	5	1	6
5:45 PM	1	0	0	0	1	1	2	0	0	3	0	1	9	2	12
Count Total	16	2	1	0	19	12	16	2	0	30	0	8	60	42	110
Peak Hour	7	2	1	0	10	8	6	1	0	15	0	3	28	32	63

Two-Hour Count Summaries - Heavy Vehicles																		
Interval Start	9th Ave				9th Ave				S Railroad Ave E				Driveway				15-min Total	Rolling One Hour
	Eastbound				Westbound				Northbound				Southbound					
	UT	LT	TH	RT	UT	LT	TH	RT	UT	LT	TH	RT	UT	LT	TH	RT		
4:00 PM	0	0	6	0	0	0	0	0	0	0	0	0	0	0	0	0	6	0
4:15 PM	0	0	0	0	0	0	0	0	0	0	0	0	0	0	0	0	0	0
4:30 PM	0	0	2	1	0	0	1	0	0	1	0	0	0	0	0	0	5	0
4:45 PM	0	0	0	0	0	0	0	0	0	0	0	0	0	0	0	0	0	11
5:00 PM	0	0	4	0	0	0	0	0	0	0	0	0	0	0	0	0	4	9
5:15 PM	0	0	0	0	0	0	1	0	0	0	0	0	0	0	0	0	1	10
5:30 PM	0	0	2	0	0	0	0	0	0	0	0	0	0	0	0	0	2	7
5:45 PM	0	0	1	0	0	0	0	0	0	0	0	0	0	0	0	0	1	8
Count Total	0	0	15	1	0	0	2	0	0	1	0	0	0	0	0	0	19	0
Peak Hour	0	0	6	1	0	0	2	0	0	1	0	0	0	0	0	0	10	0

Two-Hour Count Summaries - Bikes																	
Interval Start	9th Ave			9th Ave			S Railroad Ave E			Driveway			15-min Total	Rolling One Hour			
	Eastbound			Westbound			Northbound			Southbound							
	LT	TH	RT	LT	TH	RT	LT	TH	RT	LT	TH	RT					
4:00 PM	0	1	0	0	3	0	1	0	0	0	0	0	5	0			
4:15 PM	0	1	0	0	4	0	0	0	0	0	0	0	5	0			
4:30 PM	0	3	0	0	0	0	0	0	0	0	0	0	3	0			
4:45 PM	0	2	1	0	2	0	0	0	0	0	0	0	5	18			
5:00 PM	0	0	1	0	1	0	0	0	1	0	0	0	3	16			
5:15 PM	0	1	0	1	2	0	0	0	0	0	0	0	4	15			
5:30 PM	0	0	1	0	1	0	0	0	0	0	0	0	2	14			
5:45 PM	0	0	1	0	2	0	0	0	0	0	0	0	3	12			
Count Total	0	8	4	1	15	0	1	0	1	0	0	0	30	0			
Peak Hour	0	6	2	1	5	0	0	0	1	0	0	0	15	0			

Note: U-Turn volumes for bikes are included in Left-Turn, if any.

S Railroad Ave W 9th Ave



Peak Hour

Date: 11/16/2022
Count Period: 7:00 AM to 9:00 AM
Peak Hour: 7:45 AM to 8:45 AM

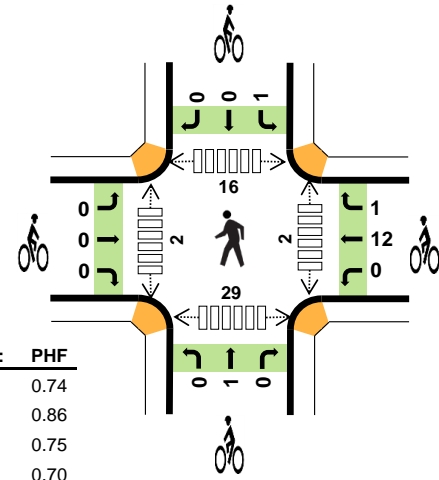
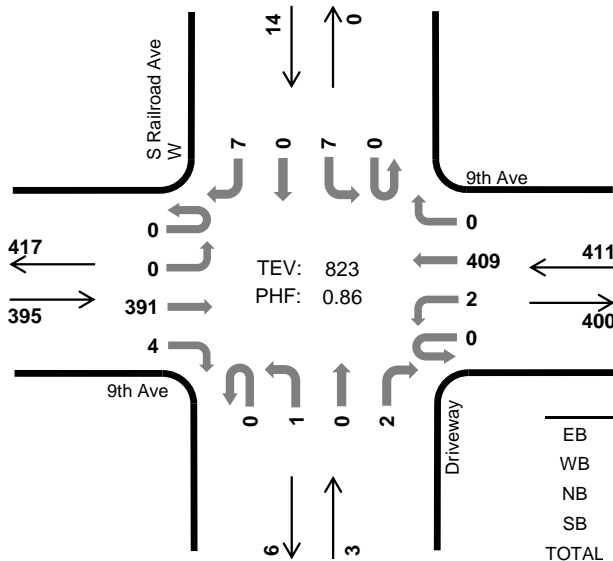

	HV %:	PHF
EB	1.5%	0.74
WB	2.2%	0.86
NB	0.0%	0.75
SB	7.1%	0.70
TOTAL	1.9%	0.86

Two-Hour Count Summaries

Interval Start	9th Ave Eastbound				9th Ave Westbound				Driveway Northbound				S Railroad Ave W Southbound				15-min Total	Rolling One Hour	
	UT	LT	TH	RT	UT	LT	TH	RT	UT	LT	TH	RT	UT	LT	TH	RT			
7:00 AM	0	0	40	0	0	0	34	0	0	0	0	0	0	0	0	1	75	0	
7:15 AM	0	0	37	0	0	0	45	0	0	0	0	0	0	3	0	1	86	0	
7:30 AM	1	0	66	1	0	0	61	0	0	2	0	0	0	0	0	0	131	0	
7:45 AM	0	0	66	0	0	0	96	0	0	0	0	1	0	3	0	0	166	458	
8:00 AM	0	0	95	2	0	1	119	0	0	0	0	0	0	0	0	2	219	602	
8:15 AM	0	0	133	1	0	1	99	0	0	0	0	1	0	2	0	2	239	755	
8:30 AM	0	0	97	1	0	0	95	0	0	1	0	0	0	2	0	3	199	823	
8:45 AM	0	0	83	0	0	0	67	0	0	1	0	0	0	0	0	0	151	808	
Count Total	1	0	617	5	0	2	616	0	0	4	0	2	0	10	0	9	1,266	0	
Peak Hour	All	0	0	391	4	0	2	409	0	0	1	0	2	0	7	0	7	823	0
	HV	0	0	6	0	0	0	9	0	0	0	0	0	0	1	0	0	16	0
	HV%	-	-	2%	0%	-	0%	2%	-	-	0%	-	0%	-	14%	-	0%	2%	0

Note: Two-hour count summary volumes include heavy vehicles but exclude bicycles in overall count.

Interval Start	Heavy Vehicle Totals					Bicycles					Pedestrians (Crossing Leg)				
	EB	WB	NB	SB	Total	EB	WB	NB	SB	Total	East	West	North	South	Total
7:00 AM	0	0	0	0	0	0	0	0	1	1	0	0	3	2	5
7:15 AM	0	5	0	2	7	1	1	0	0	2	1	1	6	2	10
7:30 AM	4	3	0	0	7	0	1	0	1	2	0	3	3	3	9
7:45 AM	1	2	0	1	4	0	6	0	0	6	0	0	2	10	12
8:00 AM	0	1	0	0	1	0	6	0	0	6	2	2	2	11	17
8:15 AM	1	2	0	0	3	0	0	1	0	1	0	0	3	2	5
8:30 AM	4	4	0	0	8	0	1	0	1	2	0	0	9	6	15
8:45 AM	2	0	0	0	2	0	1	0	2	3	1	2	5	1	9
Count Total	12	17	0	3	32	1	16	1	5	23	4	8	33	37	82
Peak Hour	6	9	0	1	16	0	13	1	1	15	2	2	16	29	49

Two-Hour Count Summaries - Heavy Vehicles																		
Interval Start	9th Ave				9th Ave				Driveway				S Railroad Ave W				15-min Total	Rolling One Hour
	Eastbound				Westbound				Northbound				Southbound					
	UT	LT	TH	RT	UT	LT	TH	RT	UT	LT	TH	RT	UT	LT	TH	RT		
7:00 AM	0	0	0	0	0	0	0	0	0	0	0	0	0	0	0	0	0	
7:15 AM	0	0	0	0	0	0	5	0	0	0	0	0	0	2	0	0	7	
7:30 AM	0	0	4	0	0	0	3	0	0	0	0	0	0	0	0	0	7	
7:45 AM	0	0	1	0	0	0	2	0	0	0	0	0	0	1	0	0	4	
8:00 AM	0	0	0	0	0	0	1	0	0	0	0	0	0	0	0	0	1	
8:15 AM	0	0	1	0	0	0	2	0	0	0	0	0	0	0	0	0	3	
8:30 AM	0	0	4	0	0	0	4	0	0	0	0	0	0	0	0	0	8	
8:45 AM	0	0	2	0	0	0	0	0	0	0	0	0	0	0	0	0	2	
Count Total	0	0	12	0	0	0	17	0	0	0	0	0	3	0	0	32	0	
Peak Hour	0	0	6	0	0	0	9	0	0	0	0	0	1	0	0	16	0	

Two-Hour Count Summaries - Bikes																	
Interval Start	9th Ave			9th Ave			Driveway			S Railroad Ave W			15-min Total	Rolling One Hour			
	Eastbound			Westbound			Northbound			Southbound							
	LT	TH	RT	LT	TH	RT	LT	TH	RT	LT	TH	RT					
7:00 AM	0	0	0	0	0	0	0	0	0	1	0	0	1	0			
7:15 AM	0	1	0	0	0	1	0	0	0	0	0	0	2	0			
7:30 AM	0	0	0	0	1	0	0	0	0	0	0	1	2	0			
7:45 AM	0	0	0	0	5	1	0	0	0	0	0	0	6	11			
8:00 AM	0	0	0	0	6	0	0	0	0	0	0	0	6	16			
8:15 AM	0	0	0	0	0	0	0	1	0	0	0	0	1	15			
8:30 AM	0	0	0	0	1	0	0	0	0	1	0	0	2	15			
8:45 AM	0	0	0	0	1	0	0	0	0	1	0	1	3	12			
Count Total	0	1	0	0	14	2	0	1	0	3	0	2	23	0			
Peak Hour	0	0	0	0	12	1	0	1	0	1	0	0	15	0			

Note: U-Turn volumes for bikes are included in Left-Turn, if any.

S Railroad Ave W 9th Ave



Peak Hour

Date: 11/16/2022
Count Period: 4:00 PM to 6:00 PM
Peak Hour: 4:30 PM to 5:30 PM

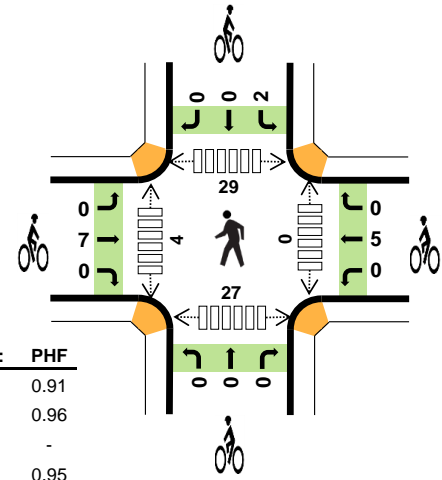
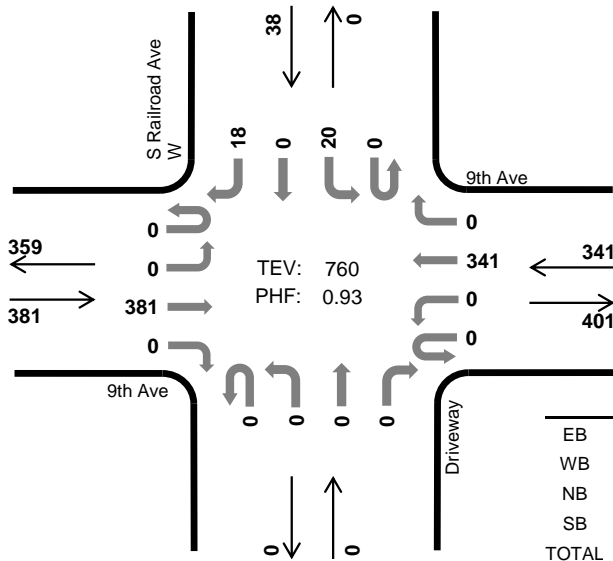

	HV %:	PHF
EB	1.8%	0.91
WB	0.9%	0.96
NB	-	-
SB	0.0%	0.95
TOTAL	1.3%	0.93

Two-Hour Count Summaries

Interval Start	9th Ave Eastbound				9th Ave Westbound				Driveway Northbound				S Railroad Ave W Southbound				15-min Total	Rolling One Hour	
	UT	LT	TH	RT	UT	LT	TH	RT	UT	LT	TH	RT	UT	LT	TH	RT			
4:00 PM	2	0	80	0	0	0	72	0	0	1	0	1	0	1	0	2	159	0	
4:15 PM	0	0	93	0	0	1	76	0	0	0	0	0	0	6	0	1	177	0	
4:30 PM	0	0	105	0	0	0	89	0	0	0	0	0	0	4	0	6	204	0	
4:45 PM	0	0	87	0	0	0	82	0	0	0	0	0	0	2	0	8	179	719	
5:00 PM	0	0	96	0	0	0	89	0	0	0	0	0	0	6	0	2	193	753	
5:15 PM	0	0	93	0	0	0	81	0	0	0	0	0	0	8	0	2	184	760	
5:30 PM	0	0	102	0	0	0	68	0	0	0	0	0	0	10	0	5	185	741	
5:45 PM	0	0	77	0	0	0	71	0	0	0	0	0	0	7	0	5	160	722	
Count Total	2	0	733	0	0	1	628	0	0	1	0	1	0	44	0	31	1,441	0	
Peak Hour	All	0	0	381	0	0	0	341	0	0	0	0	0	0	20	0	18	760	0
	HV	0	0	7	0	0	0	3	0	0	0	0	0	0	0	0	0	10	0
	HV%	-	-	2%	-	-	-	1%	-	-	-	-	-	-	0%	-	0%	1%	0

Note: Two-hour count summary volumes include heavy vehicles but exclude bicycles in overall count.

Interval Start	Heavy Vehicle Totals					Bicycles					Pedestrians (Crossing Leg)				
	EB	WB	NB	SB	Total	EB	WB	NB	SB	Total	East	West	North	South	Total
4:00 PM	6	0	0	0	6	1	4	0	1	6	1	0	4	5	10
4:15 PM	0	0	0	1	1	1	4	0	1	6	0	0	12	7	19
4:30 PM	3	2	0	0	5	2	0	0	1	3	0	1	10	9	20
4:45 PM	0	0	0	0	0	2	2	0	1	5	0	0	6	4	10
5:00 PM	4	0	0	0	4	1	1	0	0	2	0	0	4	8	12
5:15 PM	0	1	0	0	1	2	2	0	0	4	0	3	9	6	18
5:30 PM	2	0	0	0	2	1	1	0	0	2	0	0	5	1	6
5:45 PM	1	0	0	0	1	0	2	0	0	2	0	3	7	2	12
Count Total	16	3	0	1	20	10	16	0	4	30	1	7	57	42	107
Peak Hour	7	3	0	0	10	7	5	0	2	14	0	4	29	27	60

Two-Hour Count Summaries - Heavy Vehicles																		
Interval Start	9th Ave				9th Ave				Driveway				S Railroad Ave W				15-min Total	Rolling One Hour
	Eastbound				Westbound				Northbound				Southbound					
	UT	LT	TH	RT	UT	LT	TH	RT	UT	LT	TH	RT	UT	LT	TH	RT		
4:00 PM	0	0	6	0	0	0	0	0	0	0	0	0	0	0	0	0	6	0
4:15 PM	0	0	0	0	0	0	0	0	0	0	0	0	0	0	0	1	1	0
4:30 PM	0	0	3	0	0	0	2	0	0	0	0	0	0	0	0	5	0	
4:45 PM	0	0	0	0	0	0	0	0	0	0	0	0	0	0	0	0	0	12
5:00 PM	0	0	4	0	0	0	0	0	0	0	0	0	0	0	0	0	4	10
5:15 PM	0	0	0	0	0	0	1	0	0	0	0	0	0	0	0	0	1	10
5:30 PM	0	0	2	0	0	0	0	0	0	0	0	0	0	0	0	0	2	7
5:45 PM	0	0	1	0	0	0	0	0	0	0	0	0	0	0	0	0	1	8
Count Total	0	0	16	0	0	0	3	0	0	0	0	0	0	0	1	20	0	
Peak Hour	0	0	7	0	0	0	3	0	0	0	0	0	0	0	0	10	0	

Two-Hour Count Summaries - Bikes																	
Interval Start	9th Ave			9th Ave			Driveway			S Railroad Ave W			15-min Total	Rolling One Hour			
	Eastbound			Westbound			Northbound			Southbound							
	LT	TH	RT	LT	TH	RT	LT	TH	RT	LT	TH	RT					
4:00 PM	0	1	0	0	4	0	0	0	0	0	0	0	1	0	6	0	
4:15 PM	0	1	0	0	4	0	0	0	0	0	0	0	0	1	6	0	
4:30 PM	0	2	0	0	0	0	0	0	0	0	0	1	0	0	3	0	
4:45 PM	0	2	0	0	2	0	0	0	0	0	0	1	0	0	5	20	
5:00 PM	0	1	0	0	1	0	0	0	0	0	0	0	0	0	2	16	
5:15 PM	0	2	0	0	2	0	0	0	0	0	0	0	0	0	4	14	
5:30 PM	0	1	0	0	1	0	0	0	0	0	0	0	0	0	2	13	
5:45 PM	0	0	0	0	2	0	0	0	0	0	0	0	0	0	2	10	
Count Total	0	10	0	0	16	0	0	0	0	0	0	2	1	1	30	0	
Peak Hour	0	7	0	0	5	0	0	0	0	0	0	2	0	0	14	0	

Note: U-Turn volumes for bikes are included in Left-Turn, if any.

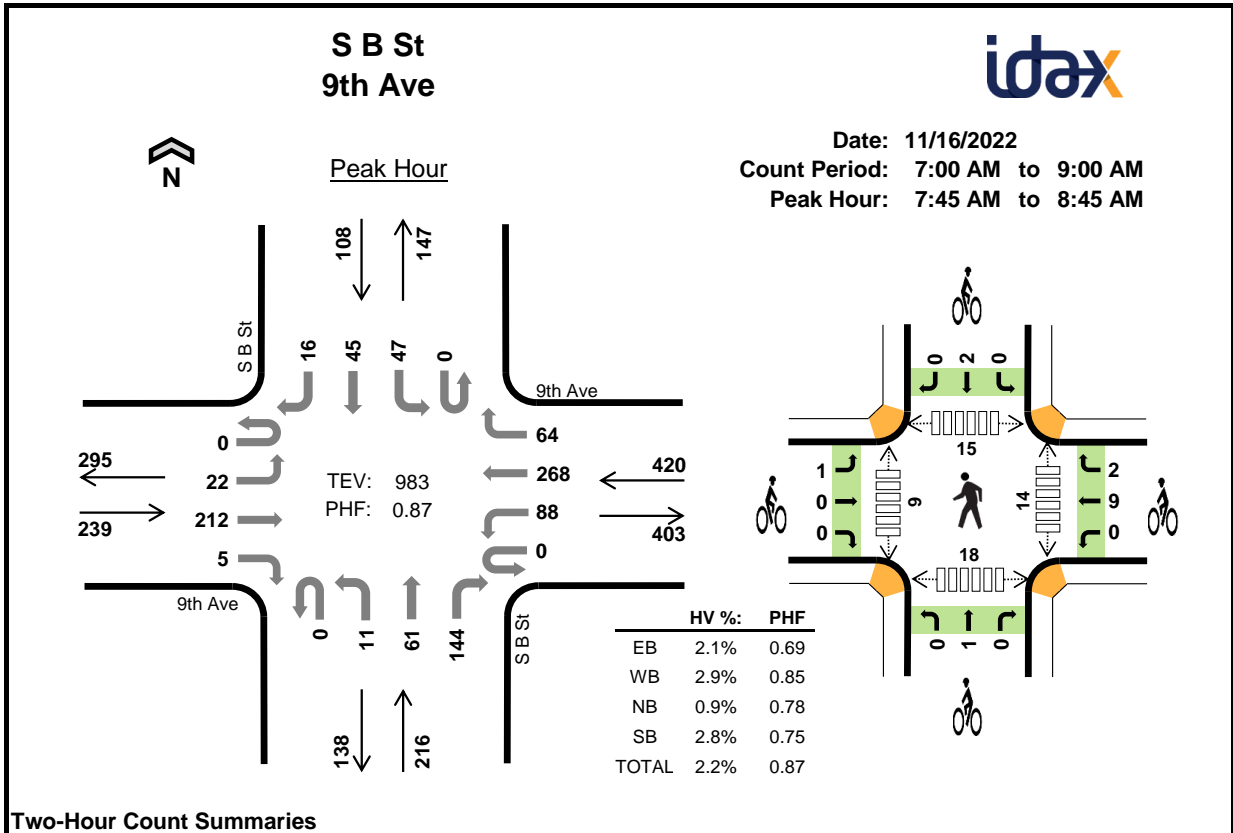

Two-Hour Count Summaries

Interval Start	9th Ave Eastbound				9th Ave Westbound				S B St Northbound				S B St Southbound				15-min Total	Rolling One Hour	
	UT	LT	TH	RT	UT	LT	TH	RT	UT	LT	TH	RT	UT	LT	TH	RT			
7:00 AM	0	2	21	2	0	17	12	5	0	2	4	20	0	2	2	2	91	0	
7:15 AM	0	5	11	0	0	5	32	7	0	6	10	24	0	4	2	7	113	0	
7:30 AM	0	5	38	1	0	8	33	10	0	3	7	27	0	5	4	1	142	0	
7:45 AM	0	3	31	0	0	19	65	19	0	1	12	24	0	11	12	5	202	548	
8:00 AM	0	3	58	0	0	29	82	13	0	6	15	39	0	15	19	2	281	738	
8:15 AM	0	9	74	3	0	16	73	10	0	4	19	46	0	10	8	4	276	901	
8:30 AM	0	7	49	2	0	24	48	22	0	0	15	35	0	11	6	5	224	983	
8:45 AM	0	11	35	2	0	13	38	13	0	1	10	32	0	14	12	5	186	967	
Count Total	0	45	317	10	0	131	383	99	0	23	92	247	0	72	65	31	1,515	0	
Peak Hour	All	0	22	212	5	0	88	268	64	0	11	61	144	0	47	45	16	983	0
	HV	0	0	4	1	0	2	9	1	0	0	1	1	0	2	1	0	22	0
	HV%	-	0%	2%	20%	-	2%	3%	2%	-	0%	2%	1%	-	4%	2%	0%	2%	0

Note: Two-hour count summary volumes include heavy vehicles but exclude bicycles in overall count.

Interval Start	Heavy Vehicle Totals					Bicycles					Pedestrians (Crossing Leg)				
	EB	WB	NB	SB	Total	EB	WB	NB	SB	Total	East	West	North	South	Total
7:00 AM	2	0	0	0	2	0	0	0	0	0	0	2	4	1	7
7:15 AM	0	1	1	0	2	0	0	1	1	2	3	2	4	1	10
7:30 AM	0	3	4	0	7	0	1	0	0	1	3	0	3	1	7
7:45 AM	1	2	0	0	3	0	1	0	0	1	5	2	1	4	12
8:00 AM	0	3	0	0	3	0	8	0	0	8	2	1	4	10	17
8:15 AM	2	3	0	0	5	0	1	1	1	3	2	1	5	1	9
8:30 AM	2	4	2	3	11	1	1	0	1	3	5	5	5	3	18
8:45 AM	1	0	1	0	2	1	2	0	0	3	5	2	6	0	13
Count Total	8	16	8	3	35	2	14	2	3	21	25	15	32	21	93
Peak Hour	5	12	2	3	22	1	11	1	2	15	14	9	15	18	56

Two-Hour Count Summaries - Heavy Vehicles																		
Interval Start	9th Ave				9th Ave				S B St				S B St				15-min Total	Rolling One Hour
	Eastbound				Westbound				Northbound				Southbound					
	UT	LT	TH	RT	UT	LT	TH	RT	UT	LT	TH	RT	UT	LT	TH	RT		
7:00 AM	0	0	1	1	0	0	0	0	0	0	0	0	0	0	0	0	2	0
7:15 AM	0	0	0	0	0	0	0	1	0	0	1	0	0	0	0	0	2	0
7:30 AM	0	0	0	0	0	1	1	1	0	0	0	4	0	0	0	0	7	0
7:45 AM	0	0	1	0	0	0	2	0	0	0	0	0	0	0	0	0	3	14
8:00 AM	0	0	0	0	0	0	3	0	0	0	0	0	0	0	0	0	3	15
8:15 AM	0	0	2	0	0	2	1	0	0	0	0	0	0	0	0	0	5	18
8:30 AM	0	0	1	1	0	0	3	1	0	0	1	1	0	2	1	0	11	22
8:45 AM	0	0	1	0	0	0	0	0	0	0	0	1	0	0	0	0	2	21
Count Total	0	0	6	2	0	3	10	3	0	0	2	6	0	2	1	0	35	0
Peak Hour	0	0	4	1	0	2	9	1	0	0	1	1	0	2	1	0	22	0

Two-Hour Count Summaries - Bikes																	
Interval Start	9th Ave			9th Ave			S B St			S B St			15-min Total	Rolling One Hour			
	Eastbound			Westbound			Northbound			Southbound							
	LT	TH	RT	LT	TH	RT	LT	TH	RT	LT	TH	RT					
7:00 AM	0	0	0	0	0	0	0	0	0	0	0	0	0	0	0	0	0
7:15 AM	0	0	0	0	0	0	0	0	0	1	0	0	1	0	0	2	0
7:30 AM	0	0	0	0	0	1	0	0	0	0	0	0	0	0	0	1	0
7:45 AM	0	0	0	0	0	1	0	0	0	0	0	0	0	0	0	1	4
8:00 AM	0	0	0	0	0	7	1	0	0	0	0	0	0	0	0	8	12
8:15 AM	0	0	0	0	0	1	0	0	1	0	0	0	1	0	0	3	13
8:30 AM	1	0	0	0	0	0	1	0	0	0	0	0	1	0	0	3	15
8:45 AM	0	1	0	0	1	0	1	0	0	0	0	0	0	0	0	3	17
Count Total	1	1	0	0	1	10	3	0	1	1	0	0	3	0	0	21	0
Peak Hour	1	0	0	0	0	9	2	0	1	0	0	0	2	0	0	15	0

Note: U-Turn volumes for bikes are included in Left-Turn, if any.

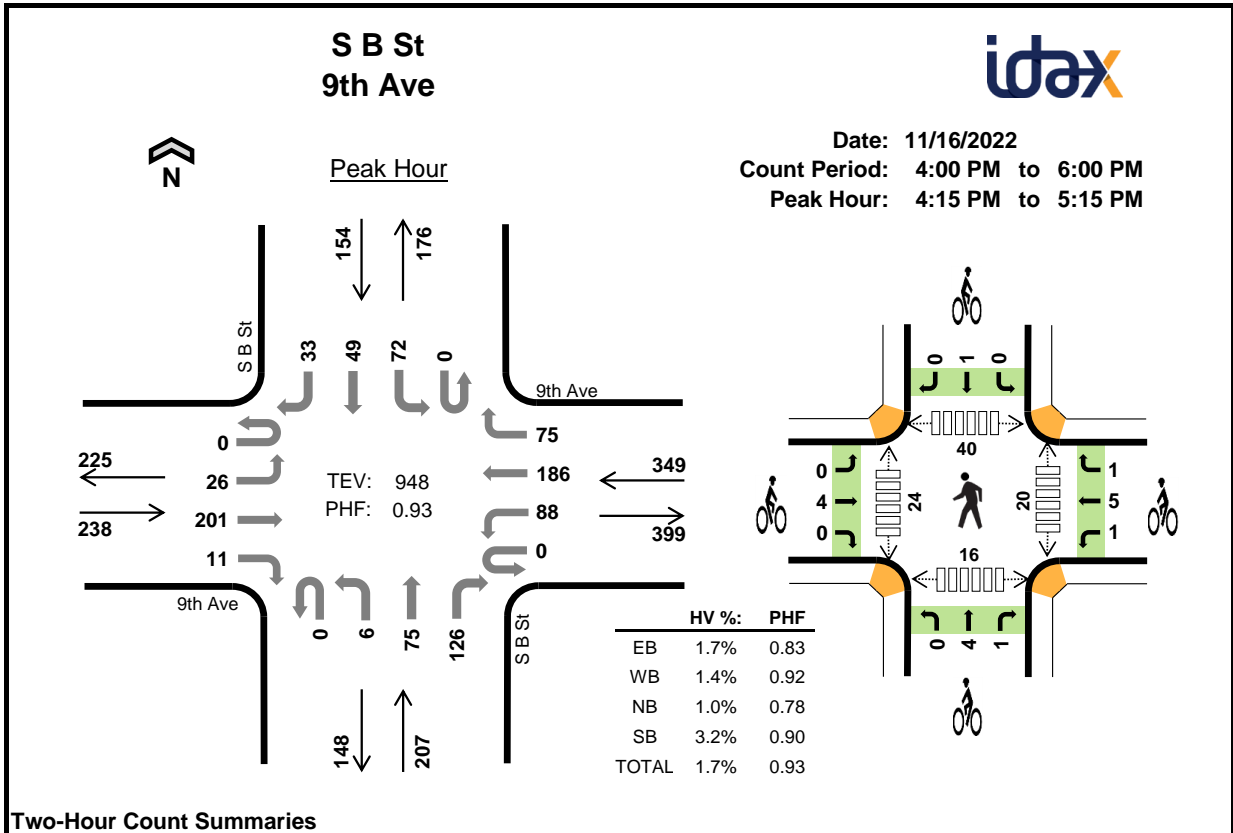

Two-Hour Count Summaries

Interval Start	9th Ave Eastbound				9th Ave Westbound				S B St Northbound				S B St Southbound				15-min Total	Rolling One Hour	
	UT	LT	TH	RT	UT	LT	TH	RT	UT	LT	TH	RT	UT	LT	TH	RT			
4:00 PM	0	13	36	1	0	21	28	20	0	0	15	27	0	15	11	11	198	0	
4:15 PM	0	8	51	2	0	18	42	17	0	1	17	28	0	19	13	11	227	0	
4:30 PM	0	6	62	4	0	25	47	17	0	2	15	26	0	20	11	6	241	0	
4:45 PM	0	9	35	3	0	25	43	20	0	1	16	35	0	17	15	7	226	892	
5:00 PM	0	3	53	2	0	20	54	21	0	2	27	37	0	16	10	9	254	948	
5:15 PM	0	8	44	3	0	19	37	20	0	1	21	31	0	14	15	4	217	938	
5:30 PM	0	12	42	2	0	14	37	26	0	2	27	42	0	16	10	8	238	935	
5:45 PM	0	12	36	2	0	24	28	15	0	4	22	33	0	8	9	7	200	909	
Count Total	0	71	359	19	0	166	316	156	0	13	160	259	0	125	94	63	1,801	0	
Peak Hour	All	0	26	201	11	0	88	186	75	0	6	75	126	0	72	49	33	948	0
	HV	0	0	4	0	0	1	2	2	0	0	1	1	0	2	0	3	16	0
	HV%	-	0%	2%	0%	-	1%	1%	3%	-	0%	1%	1%	-	3%	0%	9%	2%	0

Note: Two-hour count summary volumes include heavy vehicles but exclude bicycles in overall count.

Interval Start	Heavy Vehicle Totals					Bicycles					Pedestrians (Crossing Leg)				
	EB	WB	NB	SB	Total	EB	WB	NB	SB	Total	East	West	North	South	Total
4:00 PM	1	0	2	1	4	2	4	0	0	6	1	3	1	2	7
4:15 PM	1	1	1	3	6	1	4	1	0	6	7	6	13	2	28
4:30 PM	2	3	0	1	6	1	0	0	0	1	8	6	12	2	28
4:45 PM	0	1	0	1	2	1	2	3	1	7	2	3	11	3	19
5:00 PM	1	0	1	0	2	1	1	1	0	3	3	9	4	9	25
5:15 PM	0	6	0	0	6	0	0	1	1	2	4	7	3	4	18
5:30 PM	1	0	0	2	3	1	1	1	0	3	3	4	6	2	15
5:45 PM	0	0	1	0	1	0	1	2	0	3	5	10	7	4	26
Count Total	6	11	5	8	30	7	13	9	2	31	33	48	57	28	166
Peak Hour	4	5	2	5	16	4	7	5	1	17	20	24	40	16	100

Two-Hour Count Summaries - Heavy Vehicles																		
Interval Start	9th Ave				9th Ave				S B St				S B St				15-min Total	Rolling One Hour
	Eastbound				Westbound				Northbound				Southbound					
	UT	LT	TH	RT	UT	LT	TH	RT	UT	LT	TH	RT	UT	LT	TH	RT		
4:00 PM	0	0	1	0	0	0	0	0	0	0	1	1	0	1	0	0	4	0
4:15 PM	0	0	1	0	0	0	1	0	0	0	1	0	0	0	0	3	6	0
4:30 PM	0	0	2	0	0	1	1	1	0	0	0	0	0	1	0	0	6	0
4:45 PM	0	0	0	0	0	0	0	1	0	0	0	0	0	1	0	0	2	18
5:00 PM	0	0	1	0	0	0	0	0	0	0	0	1	0	0	0	0	2	16
5:15 PM	0	0	0	0	0	0	5	1	0	0	0	0	0	0	0	0	6	16
5:30 PM	0	1	0	0	0	0	0	0	0	0	0	0	0	2	0	0	3	13
5:45 PM	0	0	0	0	0	0	0	0	0	0	0	1	0	0	0	0	1	12
Count Total	0	1	5	0	0	1	7	3	0	0	2	3	0	5	0	3	30	0
Peak Hour	0	0	4	0	0	1	2	2	0	0	1	1	0	2	0	3	16	0

Two-Hour Count Summaries - Bikes																
Interval Start	9th Ave			9th Ave			S B St			S B St			15-min Total	Rolling One Hour		
	Eastbound			Westbound			Northbound			Southbound						
	LT	TH	RT	LT	TH	RT	LT	TH	RT	LT	TH	RT				
4:00 PM	1	1	0	1	1	2	0	0	0	0	0	0	6	0		
4:15 PM	0	1	0	0	4	0	0	1	0	0	0	0	6	0		
4:30 PM	0	1	0	0	0	0	0	0	0	0	0	0	1	0		
4:45 PM	0	1	0	1	1	0	0	3	0	0	1	0	7	20		
5:00 PM	0	1	0	0	0	1	0	0	1	0	0	0	3	17		
5:15 PM	0	0	0	0	0	0	0	1	0	0	1	0	2	13		
5:30 PM	0	1	0	0	1	0	0	1	0	0	0	0	3	15		
5:45 PM	0	0	0	1	0	0	0	1	1	0	0	0	3	11		
Count Total	1	6	0	3	7	3	0	7	2	1	1	0	31	0		
Peak Hour	0	4	0	1	5	1	0	4	1	0	1	0	17	0		

Note: U-Turn volumes for bikes are included in Left-Turn, if any.

Location: 9th Ave, Between S Railroad Ave & S Claremont St
 Date Range: 11/16/2022 - 11/22/2022
 Site Code: 01

Time	Wednesday			Thursday			Friday			Saturday			Sunday			Monday			Tuesday			Mid-Week Average		
	11/16/2022			11/17/2022			11/18/2022			11/19/2022			11/20/2022			11/21/2022			11/22/2022					
	EB	WB	Total	EB	WB	Total	EB	WB	Total	EB	WB	Total	EB	WB	Total	EB	WB	Total	EB	WB	Total	EB	WB	Total
12:00 AM	14	7	21	-	-	-	-	-	-	-	-	-	-	-	-	-	-	-	-	-	-	14	7	21
1:00 AM	9	7	16	-	-	-	-	-	-	-	-	-	-	-	-	-	-	-	-	-	-	9	7	16
2:00 AM	5	6	11	-	-	-	-	-	-	-	-	-	-	-	-	-	-	-	-	-	-	5	6	11
3:00 AM	5	7	12	-	-	-	-	-	-	-	-	-	-	-	-	-	-	-	-	-	-	5	7	12
4:00 AM	6	10	16	-	-	-	-	-	-	-	-	-	-	-	-	-	-	-	-	-	-	6	10	16
5:00 AM	35	22	57	-	-	-	-	-	-	-	-	-	-	-	-	-	-	-	-	-	-	35	22	57
6:00 AM	66	61	127	-	-	-	-	-	-	-	-	-	-	-	-	-	-	-	-	-	-	66	61	127
7:00 AM	208	231	439	-	-	-	-	-	-	-	-	-	-	-	-	-	-	-	-	-	-	208	231	439
8:00 AM	379	400	779	-	-	-	-	-	-	-	-	-	-	-	-	-	-	-	-	-	-	379	400	779
9:00 AM	193	240	433	-	-	-	-	-	-	-	-	-	-	-	-	-	-	-	-	-	-	193	240	433
10:00 AM	203	233	436	-	-	-	-	-	-	-	-	-	-	-	-	-	-	-	-	-	-	203	233	436
11:00 AM	240	200	440	-	-	-	-	-	-	-	-	-	-	-	-	-	-	-	-	-	-	240	200	440
12:00 PM	324	244	568	-	-	-	-	-	-	-	-	-	-	-	-	-	-	-	-	-	-	324	244	568
1:00 PM	284	211	495	-	-	-	-	-	-	-	-	-	-	-	-	-	-	-	-	-	-	284	211	495
2:00 PM	292	211	503	-	-	-	-	-	-	-	-	-	-	-	-	-	-	-	-	-	-	292	211	503
3:00 PM	343	246	589	-	-	-	-	-	-	-	-	-	-	-	-	-	-	-	-	-	-	343	246	589
4:00 PM	378	342	720	-	-	-	-	-	-	-	-	-	-	-	-	-	-	-	-	-	-	378	342	720
5:00 PM	366	307	673	-	-	-	-	-	-	-	-	-	-	-	-	-	-	-	-	-	-	366	307	673
6:00 PM	250	228	478	-	-	-	-	-	-	-	-	-	-	-	-	-	-	-	-	-	-	250	228	478
7:00 PM	187	140	327	-	-	-	-	-	-	-	-	-	-	-	-	-	-	-	-	-	-	187	140	327
8:00 PM	151	96	247	-	-	-	-	-	-	-	-	-	-	-	-	-	-	-	-	-	-	151	96	247
9:00 PM	94	71	165	-	-	-	-	-	-	-	-	-	-	-	-	-	-	-	-	-	-	94	71	165
10:00 PM	52	30	82	-	-	-	-	-	-	-	-	-	-	-	-	-	-	-	-	-	-	52	30	82
11:00 PM	26	21	47	-	-	-	-	-	-	-	-	-	-	-	-	-	-	-	-	-	-	26	21	47
Total	4,110	3,571	7,681	-	-	-	-	-	-	-	-	-	-	-	-	-	-	-	-	-	-	4,110	3,571	7,681
Percent	54%	46%	-	-	-	-	-	-	-	-	-	-	-	-	-	-	-	-	-	-	-	54%	46%	-
AM Peak	08:00	08:00	08:00	-	-	-	-	-	-	-	-	-	-	-	-	-	-	-	-	-	-	08:00	08:00	08:00
Vol.	379	400	779	-	-	-	-	-	-	-	-	-	-	-	-	-	-	-	-	-	-	379	400	779
PM Peak	16:00	16:00	16:00	-	-	-	-	-	-	-	-	-	-	-	-	-	-	-	-	-	-	16:00	16:00	16:00
Vol.	378	342	720	-	-	-	-	-	-	-	-	-	-	-	-	-	-	-	-	-	-	378	342	720

1. Mid-week average includes data between Tuesday and Thursday.

Location: S Claremont St, Between E 5th Ave & 9th Ave
 Date Range: 11/29/2022 - 12/5/2022
 Site Code: 02

Time	Tuesday			Wednesday			Thursday			Friday			Saturday			Sunday			Monday			Mid-Week Average		
	11/29/2022			11/30/2022			12/1/2022			12/2/2022			12/3/2022			12/4/2022			12/5/2022					
	NB	SB	Total	NB	SB	Total	NB	SB	Total	NB	SB	Total	NB	SB	Total	NB	SB	Total	NB	SB	Total	NB	SB	Total
12:00 AM	1	4	5	-	-	-	-	-	-	-	-	-	-	-	-	-	-	-	-	-	-	1	4	5
1:00 AM	0	1	1	-	-	-	-	-	-	-	-	-	-	-	-	-	-	-	-	-	-	0	1	1
2:00 AM	0	0	0	-	-	-	-	-	-	-	-	-	-	-	-	-	-	-	-	-	-	0	0	0
3:00 AM	1	1	2	-	-	-	-	-	-	-	-	-	-	-	-	-	-	-	-	-	-	1	1	2
4:00 AM	3	2	5	-	-	-	-	-	-	-	-	-	-	-	-	-	-	-	-	-	-	3	2	5
5:00 AM	10	6	16	-	-	-	-	-	-	-	-	-	-	-	-	-	-	-	-	-	-	10	6	16
6:00 AM	29	25	54	-	-	-	-	-	-	-	-	-	-	-	-	-	-	-	-	-	-	29	25	54
7:00 AM	75	60	135	-	-	-	-	-	-	-	-	-	-	-	-	-	-	-	-	-	-	75	60	135
8:00 AM	102	135	237	-	-	-	-	-	-	-	-	-	-	-	-	-	-	-	-	-	-	102	135	237
9:00 AM	71	82	153	-	-	-	-	-	-	-	-	-	-	-	-	-	-	-	-	-	-	71	82	153
10:00 AM	86	78	164	-	-	-	-	-	-	-	-	-	-	-	-	-	-	-	-	-	-	86	78	164
11:00 AM	72	82	154	-	-	-	-	-	-	-	-	-	-	-	-	-	-	-	-	-	-	72	82	154
12:00 PM	94	93	187	-	-	-	-	-	-	-	-	-	-	-	-	-	-	-	-	-	-	94	93	187
1:00 PM	86	90	176	-	-	-	-	-	-	-	-	-	-	-	-	-	-	-	-	-	-	86	90	176
2:00 PM	104	126	230	-	-	-	-	-	-	-	-	-	-	-	-	-	-	-	-	-	-	104	126	230
3:00 PM	115	94	209	-	-	-	-	-	-	-	-	-	-	-	-	-	-	-	-	-	-	115	94	209
4:00 PM	115	113	228	-	-	-	-	-	-	-	-	-	-	-	-	-	-	-	-	-	-	115	113	228
5:00 PM	98	118	216	-	-	-	-	-	-	-	-	-	-	-	-	-	-	-	-	-	-	98	118	216
6:00 PM	61	78	139	-	-	-	-	-	-	-	-	-	-	-	-	-	-	-	-	-	-	61	78	139
7:00 PM	39	38	77	-	-	-	-	-	-	-	-	-	-	-	-	-	-	-	-	-	-	39	38	77
8:00 PM	31	33	64	-	-	-	-	-	-	-	-	-	-	-	-	-	-	-	-	-	-	31	33	64
9:00 PM	13	20	33	-	-	-	-	-	-	-	-	-	-	-	-	-	-	-	-	-	-	13	20	33
10:00 PM	7	9	16	-	-	-	-	-	-	-	-	-	-	-	-	-	-	-	-	-	-	7	9	16
11:00 PM	2	3	5	-	-	-	-	-	-	-	-	-	-	-	-	-	-	-	-	-	-	2	3	5
Total	1,215	1,291	2,506	-	-	-	-	-	-	-	-	-	-	-	-	-	-	-	-	-	-	1,215	1,291	2,506
Percent	48%	52%	-	-	-	-	-	-	-	-	-	-	-	-	-	-	-	-	-	-	-	48%	52%	-
AM Peak	08:00	08:00	08:00	-	-	-	-	-	-	-	-	-	-	-	-	-	-	-	-	-	-	08:00	08:00	08:00
Vol.	102	135	237	-	-	-	-	-	-	-	-	-	-	-	-	-	-	-	-	-	-	102	135	237
PM Peak	15:00	14:00	14:00	-	-	-	-	-	-	-	-	-	-	-	-	-	-	-	-	-	-	15:00	14:00	14:00
Vol.	115	126	230	-	-	-	-	-	-	-	-	-	-	-	-	-	-	-	-	-	-	115	126	230

1. Mid-week average includes data between Tuesday and Thursday.

Intersection Operations Summary

Intersection	Control Type	LOS Threshold	Peak Hour	Existing		Opening Year		Opening Year Plus Project		Cumulative		Cumulative Plus Project	
				Delay	LOS	Delay	LOS	Delay	LOS	Delay	LOS	Delay	LOS
1. East 5 th Avenue and South Claremont Street	AWSC	E	AM	9	A	11	B	12	B	13	B	13	B
			PM	11	B	17	C	18	C	21	C	23	C
2. 9 th Avenue and South Claremont Street	AWSC	E	AM	15	B	14	B	15	B	42	E	45	E
			PM	12	B	12	B	12	B	17	C	19	C
3. 9 th Avenue and South Railroad Avenue (east)	TWSC	E	AM	15	C	17	C	17 (NB)	C	24 (NB)	C	26 (NB)	D
			PM	14	B	15	B	16 (NB)	C	19 (NB)	C	20 (NB)	C
4. 9 th Avenue and South Railroad Avenue (west)	TWSC	E	AM	16	C	16	C	16 (SB)	C	22 (SB)	C	23 (SB)	C
			PM	14	B	14	B	15 (SB)	B	18 (SB)	C	19 (SB)	C
5. 9 th Avenue and South B Street	Signal	Mid-D (45 Secs)	AM	14	B	14	B	14	B	18	C	18	C
			PM	13	B	13	B	13	B	16	B	16	B

Note: Intersections with unacceptable operations are **bolded**

Source: Fehr & Peers, 2023

